



INDUSTRIAL LIGHTING

CATALOG 2014/2015

LIKE LIGHT, SUCCESS ALWAYS COMES FROM ONE SOURCE

Waldmann's home is one of the most beautiful areas in Germany – the Black Forest. Founded in Villingen-Schwenningen, it was once an electrical installation company and is today a global player with its own distribution and production locations in 12 nations. The global presence is additionally supported by a dense network of distribution partners and cooperations. This assures a widespread and direct service.

With more than 800 employees, the owner-run SME ranks among the innovation and technology leaders when it comes to finding the right light for your workplace. Waldmann was one of the first to study the practical application of LED technology. Today, Waldmann offers LED industrial lighting for the most extreme demands and has meanwhile applied this know-how to the business sectors of architecture and medicine.

Historical highlights

- 1928: Company founded by Emil Waldmann.
- 1945: Company rebuilt by Herbert Waldmann, son of the founder.
- 1958: Launch of lighting manufacture with multipurpose and industrial task luminaires.
- 1971: Beginning of international expansion: Founding of the subsidiaries in France and Switzerland.
- 1973: Building of the current headquarters in Villingen-Schwenningen.
- 1975: Expansion of the portfolio to include medical UV therapy appliances.
- 1985: Office and task luminaires are added to the portfolio.
- 1995: With Gerhard and Rainer Waldmann, the third generation of the family-run company takes the reins.
- 2001: Company reform – introduction of the Waldmann Production System (WPS).
- 2006: Founding of the subsidiary in China.
- 2008: Founding of the subsidiary in Sweden.
- 2011: Founding of the subsidiary in India.







LIGHTING WITH THE HIGHEST STANDARDS

MANY YEARS OF EXPERIENCE

For at least 50 years Waldmann has been developing lighting solutions for a wide range of industries and applications. The perfect symbiosis of well founded application knowledge and fully developed technologies produces sustainable lighting solutions that are developed with a view to excellence in productivity, safety, health and energy saving.

CUSTOMIZED SOLUTIONS

As an “Engineer of Light”, Waldmann has for many decades provided premium quality German craftsmanship. Waldmann offers “customized lighting” that is geared toward the task and the environment. Industry customers profit from exclusive solutions and the broad range of application know-how that is tapped from the wealth of experience of innumerable system solutions and results in synergy effects.

EXPERT ADVICE

Waldmann shares its knowledge with clients and partners so that they can benefit from optimized lighting solutions. Waldmann can even provide advice to clients directly on site. The LIGHTLINER showcases all of the expertise and versatile lighting solutions offered by Waldmann in a compact format. It provides customers with a unique opportunity to find out more about the importance of having the correct lighting and to try out all of the lighting solutions available.

HOLISTIC QUALITY AWARENESS

The phrase “Made in Germany” is synonymous worldwide with integrity, reliability and the art of engineering. Waldmann grew up in this high-caliber environment and established itself as an international technology leader. The company's high standards are also reflected in active environmental management, which undergoes continuous development with certification to DIN EN 14001.

EFFICIENT LIGHT – SUSTAINABLE LIGHTING SOLUTIONS

Modern industrial workplaces are characterized by ergonomic and efficient equipment. Lighting plays a key role in both cases. Waldmann supports companies looking for solutions to reduce their electricity consumption without compromising on quality by providing specially labeled products.

Energy-optimized luminaires with high lighting quality are instantly recognizable thanks to the EFFICIENT LIGHT quality label. Waldmann's company processes are based on the principles of the Japanese KAIZEN philosophy of the continuous improvement process. Every employee is called on to actively influence the ongoing optimization process. This makes Waldmann a learning organization that reinvents itself on a daily basis. It also ensures that environmentally friendly solutions are consistently developed. The Waldmann corporate philosophy aims to ensure the responsible use of natural resources and the development of sustainable products.



efficient *light*

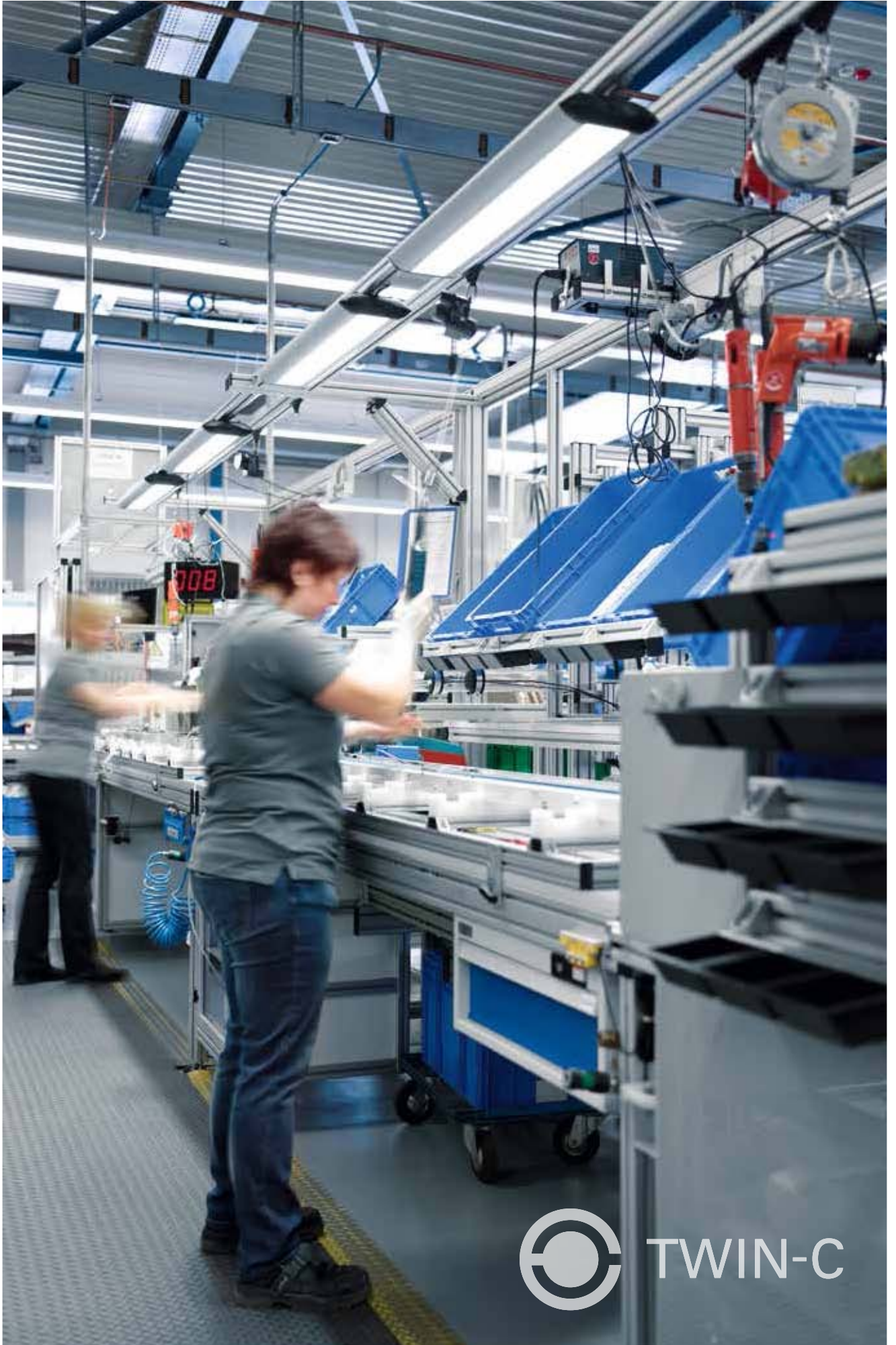

THE WALDMANN TWIN-C PHILOSOPHY LIGHTING CONCEPTS WITH ADDED VALUE

Waldmann develops and designs lighting solutions that offer added value with a view to productivity, safety, health and energy saving. After all, good lighting is a key factor when it comes to creating added value in industry. This requires the right philosophy of concepts and components – Waldmann TWIN-C. TWIN-C provides the optimum lighting solution in four steps: analysis, concept, selection and definition of the right components and implementation of the solution.

PRODUCTIVITY – INCREASE OF UP TO 40 % POSSIBLE

The correct lighting is crucial for productivity because it has a significant impact on employee performance. An intelligent lighting concept is necessary for improving performance – one which recognizes employee needs and ideally taps the potential of their work stations: **TWIN-C**.

- Light improves performance.
- Light reduces error and scrap rates.
- Light combats fatigue, which in turn improves quality.

SAFETY – ACCIDENTS REDUCED BY UP TO TWO-THIRDS

Analyses have shown that insufficient lighting is a significant factor in work-related accidents. Unlike expensive safety measures, lighting concepts from Waldmann offer much more efficient solutions.

- More light means fewer work-related accidents.
- Light minimizes the number and the extent of injuries.
- Light ensures alert, focused employees.

THE WALDMANN TWIN-C PHILOSOPHY INTELLIGENT LIGHTING

In the face of rising energy costs, exploiting energy-saving potential has become increasingly important for companies. However, saving energy doesn't mean that you have to compromise on light and comfort. Intelligent and workplace-oriented lighting solutions are essential. Demographic change is also pushing the issue of lighting to the fore – consider the fact that lighting needs increase with advancing age and the number of older employees in companies is set to grow over the coming years. A modern lighting solution must take these individual requirements into account.

HEALTH – GREATER WELLBEING

Age and deficiency symptoms, light sensitivity and headaches are just some of the areas where a lighting concept can be useful and contribute to better health. Lighting has the most positive effect when it is adjusted to the specific needs of each employee. For older employees or people working nights or shifts, it has long-term health benefits.

- Light combats the symptoms of aging.
- Light should prevent glare and reflection.
- Individually adjustable light makes people more productive.

ENERGY SAVING – TWO-FIGURE PERCENTAGE RATES ARE NO RARITY

TWIN-C lighting solutions ensure that light is used exactly where it is needed – and reduced where too much energy is being consumed unnecessarily. On every production line and in every machine, intelligent lighting concepts save energy – and increase illuminance. Waldmann uses energy-saving and high-quality lighting solutions.

- Intelligent lighting concepts save energy.
- More economical use of room-related lighting.
- Lighting is only used where it is needed.



 TWIN-C

THE RIGHT LIGHT FOR EVERY INDUSTRIAL APPLICATION

In industry, the right lighting in the right place is a vital factor for increasing productivity and employee motivation. Effortlessly being able to master visual tasks influences employee performance, quality of work and safety at the workplace. The spectrum of these requirements is so diverse that there can be no generally valid and solely correct workplace lighting.

All Waldmann's lighting components were thus developed based on the specific features and requirements of the respective work process. Simple symbols on the product pages indicate the relevant fields of application and make it easier to select the right lighting components to suit your requirements.



RESEARCH AND DEVELOPMENT

- Arm-mounted luminaires
- Flexible-tube luminaires
- Magnifier luminaires
- System luminaires

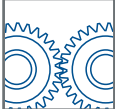

MACHINE

- Integrated machine luminaires
- Surface-mounted luminaires
- Tube luminaires
- Arm-mounted luminaires
- Flexible-tube luminaires
- Pivoting head luminaires



PRODUCTION

- Arm-mounted luminaires
- Flexible-tube luminaires
- Magnifier luminaires
- Workplace system luminaires



INSPECTION AND MONITORING

- Arm-mounted luminaires
- Flexible-tube luminaires
- Magnifier luminaires
- Workplace system luminaires
- Inspection luminaires



MAINTENANCE

- Hand-held luminaires







INTEGRATED MACHINE
LUMINAIRES 18 - 27

SURFACE-MOUNTED
LUMINAIRES 28 - 47

TUBE LUMINAIRES 48 - 59

ARM-MOUNTED LUMINAIRES 60 - 85

FLEXIBLE-TUBE LUMINAIRES 86 - 101

PIVOTING-HEAD LUMINAIRES 102 - 117

MAGNIFIER LUMINAIRES 118 - 129

WORKPLACE-SYSTEM
LUMINAIRES 130 - 143

INSPECTION LUMINAIRES 144 - 147

HAND-HELD LUMINAIRES 148 - 155

ACCESSORIES 156 - 164

INTEGRATED MACHINE LUMINAIRES

Integrated machine luminaires are particularly suitable for wide-range lighting of workpieces and processing areas. They are very resistant under extreme conditions. The compact integration offers no surface for dirt or chips to settle and provides more space in the processing area.



FLATTEC		   <p>IP68-1 m & IPX9K</p>	20 - 21	
MACH LED PRO		   <p>LED</p> <p>IP67</p>	22 - 23	
FLAT LED		  <p>LED</p> <p>IP67 & IPX9K</p>	24 - 25	
SPOT LED			  <p>LED</p> <p>IP67</p>	26 - 27

Integrated machine luminaires



FLAT TEC

BUILT-IN PEAK PERFORMANCE.

Ideally, a luminaire should take up as little space as possible and offer a high efficiency. FLAT TEC not only provides the right illuminance for every machine. It also impressively demonstrates how much light you can generate with the minimum energy.

- Optimum efficiency at high ambient temperatures
- No interference with the moving parts of the machine
- No settlement of chips
- Extremely glare-free
- High system of protection
- For the toughest application conditions
- Resistance-tested with many cooling agents and lubricants

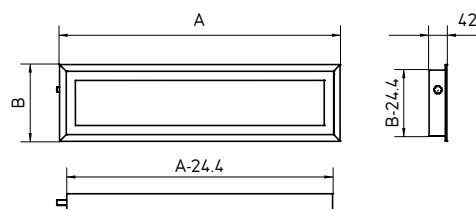

Tip: For the precise assembly dimensions, please request a detailed drawing.

Features at a glance

- TC-SEL compact fluorescent lamps or T16 fluorescent lamp(s)
- Color temperature daylight white 6,000 K (TC-SEL) or 6,500 K (T16)
- Glare-free thanks to conical prismatic screen (CDP)
- Colorless anodized aluminum housing, 3 mm thick safety glass
- Integration in recess with screws
- Without switch
- System of protection IP68-1m and IPX9K in accordance with DIN 40050-9; class of protection I
- Supplied without mains lead, connection via M12 plug connector
- Ready-made M12 plug socket as accessory

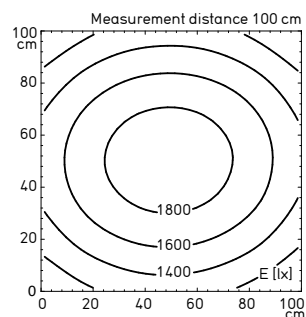

Illuminance based on the example
2 x 54 W



Integrated machine luminaires

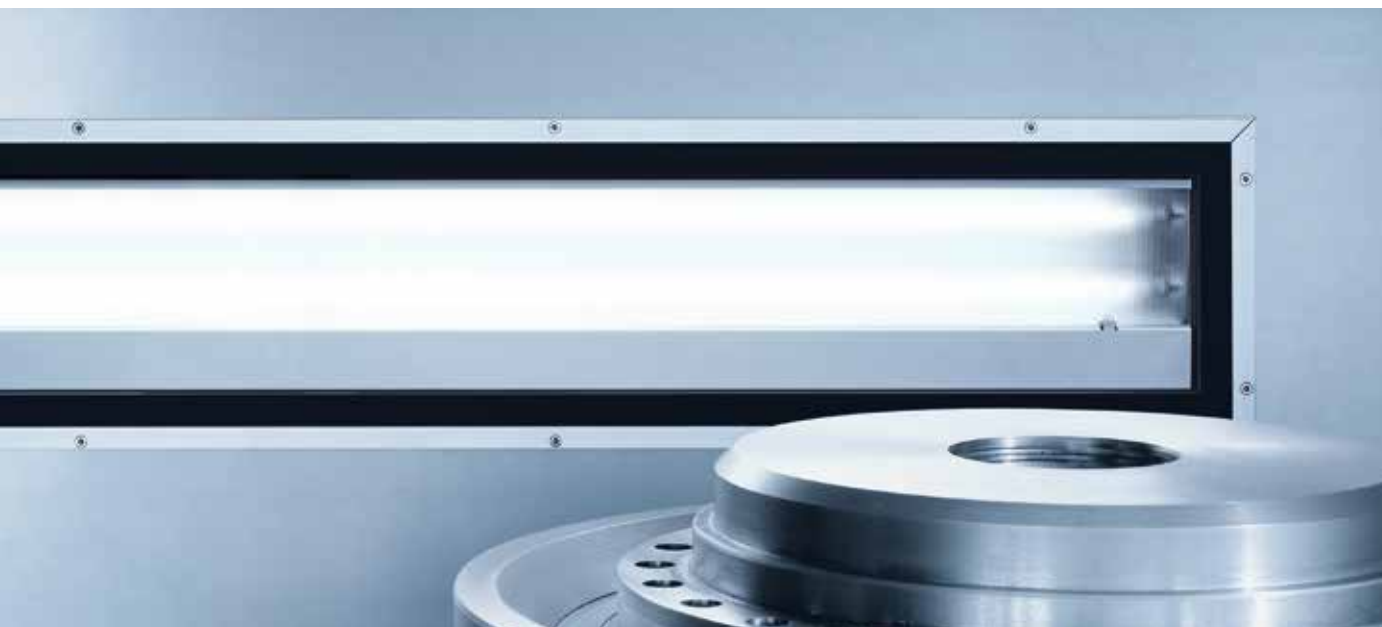

220 – 240 V, 50 HZ

FITTED WITH	OPERATING DEVICE	DIMENSIONS	SPECIAL FEATURE	E_m / E_{max}^*	MODEL	ORDER NO.
2 x 11 WTC-SEL	Integrated electronic ballast	A = 340 mm x B = 300 mm	–	304/388 lx ¹	MZEC 211 N	112 997 000 - 005 555 09
3 x 24 WT16	Integrated electronic ballast	A = 660 mm x B = 300 mm	–	1000/1274 lx ¹	MZE 324 N	112 999 000 - 005 555 16

100 – 250 V, 50/60 HZ

FITTED WITH	OPERATING DEVICE	DIMENSIONS	SPECIAL FEATURE	E_m / E_{max}^*	MODEL	ORDER NO.
1 x 24 WT16	Integrated electronic ballast	A = 660 mm x B = 180 mm	–	363/466 lx ¹	MZE 124 N	113 006 000 - 005 555 94
1 x 39 WT16	Integrated electronic ballast	A = 960 mm x B = 180 mm	–	601/766 lx ¹	MZE 139 N	113 009 000 - 005 556 34
1 x 54 WT16	Integrated electronic ballast	A = 1260 mm x B = 180 mm	–	874/1089 lx ¹	MZE 154 N	113 011 000 - 005 556 64
2 x 24 WT16	Integrated electronic ballast	A = 660 mm x B = 220 mm	–	669/863 lx ¹	MZE 224 N	113 002 000 - 005 555 45
2 x 39 WT16	Integrated electronic ballast	A = 960 mm x B = 220 mm	–	1096/1395 lx ¹	MZE 239 N	113 004 000 - 005 555 67
2 x 54 WT16	Integrated electronic ballast	A = 1260 mm x B = 220 mm	–	1546/1921 lx ¹	MZE 254 N	113 013 000 - 005 556 82

100 – 277 V, 50/60 HZ cETLus-variantes (not CE-conform)

FITTED WITH	OPERATING DEVICE	DIMENSIONS	SPECIAL FEATURE	E_m / E_{max}^*	MODEL	ORDER NO.
1 x 24 WT16	Integrated electronic ballast	A = 660 mm x B = 180 mm	–	363/466 lx ¹	MZE 124 N	113 007 000 - 005 556 03
1 x 39 WT16	Integrated electronic ballast	A = 960 mm x B = 180 mm	–	601/766 lx ¹	MZE 139 N	113 010 000 - 005 556 40
1 x 54 WT16	Integrated electronic ballast	A = 1260 mm x B = 180 mm	–	874/1089 lx ¹	MZE 154 N	113 012 000 - 005 556 73
2 x 24 WT16	Integrated electronic ballast	A = 660 mm x B = 220 mm	–	669/863 lx ¹	MZE 224 N	113 003 000 - 005 555 54
2 x 39 WT16	Integrated electronic ballast	A = 960 mm x B = 220 mm	–	1096/1395 lx ¹	MZE 239 N	113 005 000 - 005 555 70
2 x 54 WT16	Integrated electronic ballast	A = 1260 mm x B = 220 mm	–	1546/1921 lx ¹	MZE 254 N	113 014 000 - 005 556 88

24 VDC

FITTED WITH	OPERATING DEVICE	DIMENSIONS	SPECIAL FEATURE	E_m / E_{max}^*	MODEL	ORDER NO.
2 x 11 WTC-SEL	Integrated electronic ballast	A = 340 mm x B = 300 mm	–	304/388 lx ¹	MZEC 211 S	112 997 000 - 005 555 03
1 x 24 WT16	Integrated electronic ballast	A = 660 mm x B = 180 mm	–	363/466 lx ¹	MZE 124 S	112 995 000 - 005 554 56
1 x 39 WT16	Integrated electronic ballast	A = 960 mm x B = 180 mm	–	601/766 lx ¹	MZE 139 S	112 996 000 - 005 554 81

* E_m = medium illuminance; E_{max} = maximum illuminance; ¹ Measuring range 100 cm x 100 cm / Measuring distance 100 cm
 Also available as a surface-mounted luminaire

MACH LED PRO

INCREDIBLY VARIABLE, CAN BE UNOBTRUSIVELY INTEGRATED.



Even though the requirements for a machine design tend to be individual, they have one thing in common: they are not necessarily tailored to the luminaire. It is for precisely this reason that the model series MACH LED PRO embodies absolute variability in terms of area lighting. This is thanks to designs of different lengths with 1, 2, 3 or 4 LEDs and possibilities to control the light with the latest LED technology. That means that this luminaire practically disappears within the machine wall thanks to the unique construction principle that is based on the established MACH LED platform.

- Standard-compliant lighting for every lighting and room situation
- Constantly high lighting quality in the long term
- Direct connection to 24 V without additional components
- Variants with narrow and wide angles of illumination
- Ideal for high mechanical and thermal stress
- High system of protection
- Maintenance-free: LED life of up to 50,000 hours and more
- Unlimited functionality irrespective of frequent switching or fluctuations of mains voltage
- Resistance-tested with many cooling agents and lubricants



efficient *light*

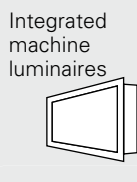
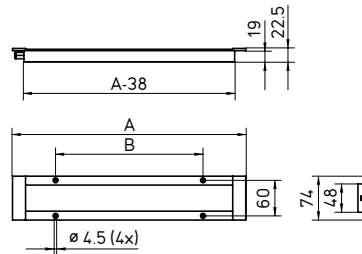

Features at a glance

- 1, 2, 3 or 4 x HIGH POWER LED
- Color temperature neutral white 5,000 K
- Direct illumination or 30° angle of illumination (lens)
- Aluminum colored anodized housing, 4 mm thick safety glass
- Integration in recess with screws
- Without switch
- System of protection IP67; class of protection III
- Supplied with 3 m mains lead and free stranded wires
- Driver to connect to the mains voltage as an accessory

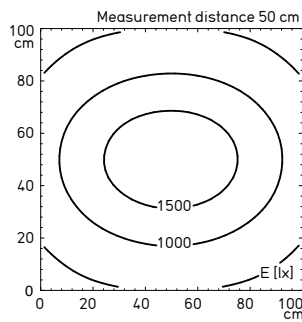

Illuminance based on the example of 24 W without lens (95°)

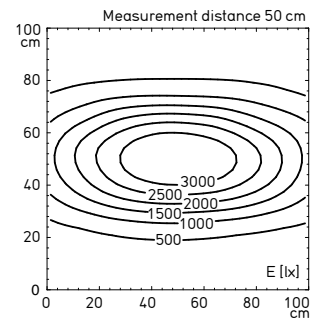

Illuminance based on the example of 24 W with 30° lens

20 – 28 VDC

CONSUMPTION	OPERATING DEVICE	DIMENSIONS	SPECIAL FEATURE	E_m / E_{max}^*	MODEL	ORDER NO.
6 W	–	A = 220 x 74 mm B = 125 mm (1x)	–	261/560 lx ¹	MUEL 1 S	112 571 002 - 000 852 16
6 W	–	A = 220 x 74 mm B = 125 mm (1x)	30° lens	333/1224 lx ¹	MUEL 1 S	112 571 000 - 000 845 79
12 W	–	A = 395 x 74 mm B = 250 mm (1x)	–	527/1065 lx ¹	MUEL 2 S	112 571 006 - 000 852 24
12 W	–	A = 395 x 74 mm B = 250 mm (1x)	30° lens	612/2186 lx ¹	MUEL 2 S	112 571 004 - 000 852 20
18 W	–	A = 570 x 74 mm B = 200 mm (2x)	–	758/1459 lx ¹	MUEL 3 S	112 571 012 - 000 852 28
18 W	–	A = 570 x 74 mm B = 200 mm (2x)	30° lens	922/3061 lx ¹	MUEL 3 S	112 571 010 - 000 852 27
24 W	–	A = 745 x 74 mm B = 250 mm (2x)	–	1001/1820 lx ¹	MUEL 4 S	112 571 016 - 000 852 76
24 W	–	A = 745 x 74 mm B = 250 mm (2x)	30° lens	1122/3429 lx ¹	MUEL 4 S	112 571 014 - 000 852 75

20 – 28 VAC

CONSUMPTION	OPERATING DEVICE	DIMENSIONS	SPECIAL FEATURE	E_m / E_{max}^*	MODEL	ORDER NO.
6 W	–	A = 220 x 74 mm B = 125 mm (1x)	–	261/560 lx ¹	MUEL 1 S	112 571 003 - 000 851 94
6 W	–	A = 220 x 74 mm B = 125 mm (1x)	30° lens	333/1224 lx ¹	MUEL 1 S	112 571 001 - 000 851 27
12 W	–	A = 395 x 74 mm B = 250 mm (1x)	–	527/1065 lx ¹	MUEL 2 S	112 571 007 - 000 852 26
12 W	–	A = 395 x 74 mm B = 250 mm (1x)	30° lens	612/2186 lx ¹	MUEL 2 S	112 571 005 - 000 852 25
18 W	–	A = 570 x 74 mm B = 200 mm (2x)	–	758/1459 lx ¹	MUEL 3 S	112 571 013 - 000 852 57
18 W	–	A = 570 x 74 mm B = 200 mm (2x)	30° lens	922/3061 lx ¹	MUEL 3 S	112 571 011 - 000 852 56
24 W	–	A = 745 x 74 mm B = 250 mm (2x)	–	1001/1820 lx ¹	MUEL 4 S	112 571 017 - 000 853 11
24 W	–	A = 745 x 74 mm B = 250 mm (2x)	30° lens	1122/3429 lx ¹	MUEL 4 S	112 571 015 - 000 852 78

* E_m = medium illuminance; E_{max} = maximum illuminance; ¹ Measuring range 100 cm x 100 cm/Measuring distance 50 cm

Also available as a surface-mounted luminaire

FLAT LED

INGENIOUSLY INTEGRATED LED TECHNOLOGY.

It has practically become essential for the luminaires integrated in the increasingly compact machines to be small and powerful. This is precisely why Waldmann developed the FLAT LED: Its 6 LEDs provide optimum area light in spite of their compressed construction and low integration depth.

- Compact
- Constantly high lighting quality in the long term
- For strong, wide-range and even lighting
- Direct connection to 24 V without additional components
- No surface that is subject to the bombardment of chips
- Resistance-tested with many cooling agents and lubricants
- High system of protection
- Maintenance-free: LED life of up to 50,000 hours and more
- For tough application conditions

•••••
LED



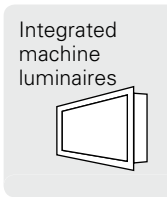

efficient^{light}

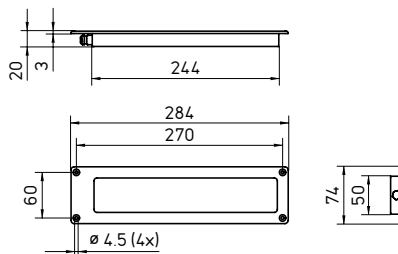

Features at a glance

- 6 x HIGH POWER LED
- Color temperature daylight white 6,500 K
- 60° angle of illumination
- Black aluminum anodized housing, 4 mm thick safety glass
- Integration in recess with screws
- Without switch
- System of protection IP67 and IPX9K in accordance with DIN 40050-9; class of protection III
- Supplied with 3 m mains lead and free stranded wires
- Driver to connect to the mains voltage as an accessory

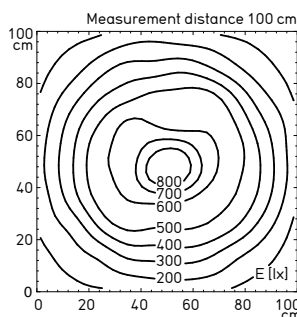

Illuminance 13 W

10 – 40 VDC

CONSUMPTION	OPERATING DEVICE	DIMENSIONS	SPECIAL FEATURE	E_m / E_{max}^*	MODEL	ORDER NO.
13 W	–	284 x 74 mm	–	347/869 lx ¹	MYEL 6 S	112 560 001 - 000 031 66

10 – 30 VAC

CONSUMPTION	OPERATING DEVICE	DIMENSIONS	SPECIAL FEATURE	E_m / E_{max}^*	MODEL	ORDER NO.
13 W	–	284 x 74 mm	–	347/869 lx ¹	MYEL 6 S	112 560 003 - 000 062 73

* E_m = medium illuminance; E_{max} = maximum illuminance; ¹ Measuring range 100 cm x 100 cm/Measuring distance 100 cm
 Also available as a surface-mounted luminaire

SPOT LED



CONCENTRATED LIGHT WITH LOW SPACE REQUIREMENTS.



The SPOT LED for permanent integration in the machine combines 3 LEDs in such compact housing that you could hardly imagine a smaller luminaire.

- Permanently high lighting quality
- Particularly space-saving integration
- No surface that is subject to the accumulation of chips
- Variants with narrow and wide angles of illumination
- Direct connection to 24 V without additional components
- Resistance-tested with many cooling agents and lubricants
- High system of protection
- Maintenance-free: LED life of up to 50,000 hours and more
- Unlimited functionality irrespective of frequent switching or fluctuations of mains voltage



efficient *light*

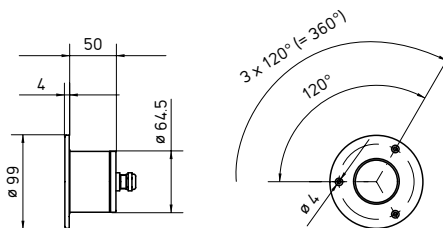

Integrated machine luminaires

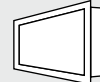

Features at a glance

- 3 x HIGH POWER LED
- Color temperature daylight white 5,700 K
- 10° or 40° angle of illumination
- Black aluminum anodized housing, 3 mm thick safety glass
- Integration in recess with screws
- Without switch
- System of protection IP67; class of protection III
- Supplied with 3 m mains lead and free stranded wires
- Ballast to connect to the mains voltage as an accessory

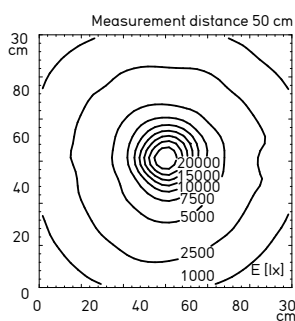

Illuminance with 10° lens

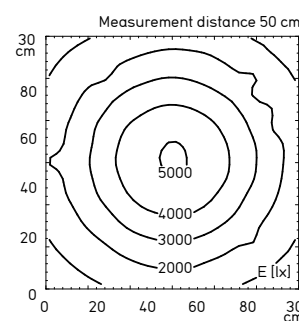

Illuminance with 40° lens

16 – 30 VAC / 16 – 40 VDC

CONSUMPTION	OPERATING DEVICE	DIMENSIONS	SPECIAL FEATURE	E_m/E_{max} *	MODEL	ORDER NUMBER
6 W	–	ø 99 mm	10° lens	3358/22350 lx ¹	MCEYL 3 S	112 460 001 - 000 829 95
6 W	–	ø 99 mm	40° lens	2539/5095 lx ¹	MCEYL 3 S	112 460 003 - 000 878 91

* E_m = Medium illuminance; E_{max} = Maximum illuminance; ¹ Measuring range 30 cm x 30 cm / Measuring distance 50 cm
 Also available as an arm-mounted luminaire, flexible tube luminaire, pivoting-head luminaire and surface-mounted luminaire

SURFACE-MOUNTED LUMINAIRES

Surface-mounted luminaires are designed to withstand the toughest stress and can also be retrofitted in machines and systems. The flexible positioning enables an individual adjustment to space and lighting conditions.



LUMATRIS	 		 	IP68-1 m & IPX9K	30 - 31
FLATTEC			 	IP68-1 m & IPX9K	32 - 33
MACH LED			  	IP67	34 - 35
MACH LED PRO			  	IP67	36 - 37
FLAT LED			 	IP67 & IPX9K	38 - 39
SPOT LED	 		 	IP67	40 - 41
HEAD LED			 	IP67	42 - 43
SLIM LED			 	IP67	44 - 45
ONE LED			 	IP54 or IP67	46 - 47

Integrated
machine
luminairesSurface-
mounted
luminaires

LUMATRIS



EVOLUTION IN MACHINE LIGHTING.



In mechanical engineering, competitive ability equals the sum of innovative components and functions.

LUMATRIS now makes the latest LED technology available to medium- and large-volume machines. It economically transforms the punctiform lighting characteristic of LEDs into extremely homogeneous area light.

- Maintenance-free: LED life of up 50,000 hours and more
- Variants with Light Forming Technology for optimum light control and 30 % more efficiency
- Extremely resource-friendly operation thanks to eco mode
- Flicker-free light with no IR or UV content
- Unlimited functionality even after frequent switching
- Direct, reverse-polarity protected 24 VDC plug with no additional components
- Rear or side plug connection with an M12 plug connector
- For integration or mounting
- Versatile mounting options with thread channels and T-slots on the rear or accessories optimized for requirements
- Robust aluminum and safety glass housing for the toughest application conditions
- IP68-1m and IPX9K system of protection
- For ambient temperatures of up to 50° C
- No burning-in of cooling agents or lubricants thanks to low surface temperature
- Resistance-tested with many cooling agents and lubricants





LUMATRIS with side plug connection

efficient *light*

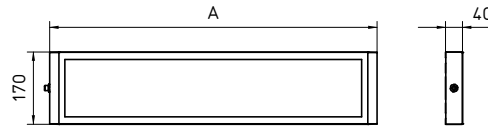

Tip: For the precise assembly dimensions, please request a detailed drawing.

Integrated machine luminaires



Surface-mounted luminaires



Features at a glance

- 90 or 180 x LED
- Color temperature daylight white 5,800 K
- Glare-free with diffuser or Light Forming Technology
- Colorless anodized aluminum housing, silver-painted side parts made of die-cast zinc, 4 mm thick safety glass
- Screw-mounted (thread channels/T-slots) or various fastenings from the range of accessories
- Switchable in two stages (eco mode), without switch
- System of protection IP68-1m and IPX9K in accordance with DIN 40050-9; class of protection III
- Supplied without mains lead, side or rear connection via M12 plug connector
- Mounting frame, mounting brackets, jointed head, operating devices for connection to mains voltage and customizable M12 sleeves as accessories

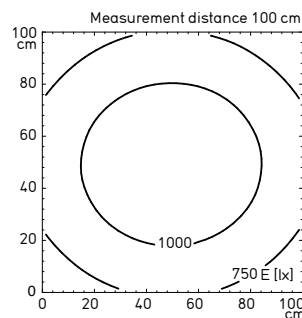

Illuminance based on the example 62 W without Light Forming Technology

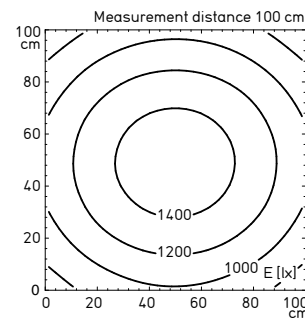

Illuminance based on the example 62 W with Light Forming Technology

22 – 26 VDC						
CONSUMPTION	OPERATING DEVICE	DIMENSIONS	SPECIAL FEATURE	E_m/E_{max}^*	MODEL	ORDER NUMBER
31 W	–	A = 420 x 170 mm	Rear connection Light Forming Technology	588/786 lx ¹	MSAL 90 S	112 573 000 - 004 994 89
31 W	–	A = 420 x 170 mm	Side connection Light Forming Technology	588/786 lx ¹	MSAL 90 S	112 573 001 - 005 142 71
31 W	–	A = 420 x 170 mm	Side connection	501/665 lx ¹	MSAL 90 S	112 573 002 - 005 142 74
31 W	–	A = 420 x 170 mm	Rear connection	501/665 lx ¹	MSAL 90 S	112 573 003 - 005 142 77
62 W	–	A = 770 x 170 mm	Rear connection Light Forming Technology	1156/1511 lx ¹	MSAL 180 S	112 574 000 - 004 994 93
62 W	–	A = 770 x 170 mm	Side connection Light Forming Technology	1156/1511 lx ¹	MSAL 180 S	112 574 001 - 005 111 40
62 W	–	A = 770 x 170 mm	Side connection	964/1248 lx ¹	MSAL 180 S	112 574 002 - 005 111 44
62 W	–	A = 770 x 170 mm	Rear connection	964/1248 lx ¹	MSAL 180 S	112 574 003 - 005 111 47

* E_m = Medium illuminance; E_{max} = Maximum illuminance; ¹ Measuring range 100 cm x 100 cm/Measuring distance 100 cm

FLAT TEC

THE ULTIMATE IN LIGHTING AND HOUSING TECHNOLOGY.

No light without energy. With this in mind, FLAT TEC skillfully uses as little energy as possible to generate the maximum amount of light. It does so with a housing shape that is so flat that it doesn't even appear obtrusive when positioned as a surface-mounted luminaire in the center of activity.

- Maximum light with minimum energy consumption
- For the toughest application conditions
- Hardly any interference with the moving parts of the machine
- Resistance-tested with many cooling agents and lubricants
- Extremely glare-free
- Optimum efficiency at high ambient temperatures
- High system of protection





efficient *light*

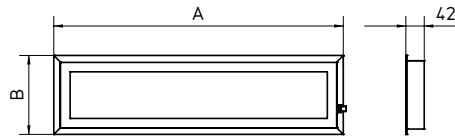

Tip: For the precise assembly dimensions, please request a detailed drawing.

Integrated machine luminaires



Surface-mounted luminaires



Features at a glance

- TC-SEL compact fluorescent lamps or T16 fluorescent lamp(s)
- Color temperature daylight white 6,000 (TC-SEL) or 6,500 K (T16)
- Glare-free thanks to conical prismatic screen (CDP)
- Aluminum colored anodized housing, 3 mm thick safety glass
- Screw-mounted
- Without switch
- System of protection IP68-1m and IPX9K in accordance with DIN 40050-9; class of protection I
- Supplied without mains lead, connection via M12 plug connector
- Ready-made M12 plug socket as accessory

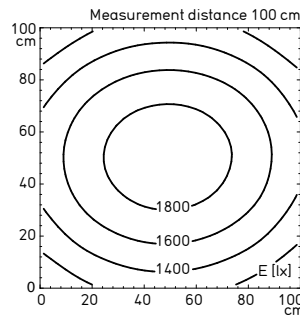

Illuminance based on the example 2 x 54 W

220 – 240 V, 50 HZ

FITTED WITH	OPERATING DEVICE	DIMENSIONS	SPECIAL FEATURE	E_m / E_{max}^*	MODEL	ORDER NO.
2 x 11 WTC-SEL	Integrated electronic ballast	A = 340 mm x B = 300 mm	–	304/388 lx ¹	MZAC 211 N	112 997 000 - 005 555 12
3 x 24 WT16	Integrated electronic ballast	A = 660 mm x B = 300 mm	–	1000/1274 lx ¹	MZA 324 N	112 999 000 - 005 555 19

100 – 250 V, 50/60 HZ

FITTED WITH	OPERATING DEVICE	DIMENSIONS	SPECIAL FEATURE	E_m / E_{max}^*	MODEL	ORDER NO.
1 x 24 WT16	Integrated electronic ballast	A = 660 mm x B = 180 mm	–	363/466 lx ¹	MZA 124 N	113 006 000 - 005 556 00
1 x 39 WT16	Integrated electronic ballast	A = 960 mm x B = 180 mm	–	601/766 lx ¹	MZA 139 N	113 009 000 - 005 556 37
1 x 54 WT16	Integrated electronic ballast	A = 1260 mm x B = 180 mm	–	874/1089 lx ¹	MZA 154 N	113 011 000 - 005 556 67
2 x 24 WT16	Integrated electronic ballast	A = 660 mm x B = 220 mm	–	669/863 lx ¹	MZA 224 N	113 002 000 - 005 555 48
2 x 39 WT16	Integrated electronic ballast	A = 960 mm x B = 220 mm	–	1096/1395 lx ¹	MZA 239 N	113 004 000 - 005 555 61
2 x 54 WT16	Integrated electronic ballast	A = 1260 mm x B = 220 mm	–	1546/1921 lx ¹	MZA 254 N	113 013 000 - 005 556 85

100 – 277 V, 50/60 HZ cETLus-variants (not CE-conform)

FITTED WITH	OPERATING DEVICE	DIMENSIONS	SPECIAL FEATURE	E_m / E_{max}^*	MODEL	ORDER NO.
1 x 24 WT16	Integrated electronic ballast	A = 660 mm x B = 180 mm	–	363/466 lx ¹	MZA 124 N	113 007 000 - 005 556 06
1 x 39 WT16	Integrated electronic ballast	A = 960 mm x B = 180 mm	–	601/766 lx ¹	MZA 139 N	113 010 000 - 005 556 43
1 x 54 WT16	Integrated electronic ballast	A = 1260 mm x B = 180 mm	–	874/1089 lx ¹	MZA 154 N	113 012 000 - 005 556 76
2 x 24 WT16	Integrated electronic ballast	A = 660 mm x B = 220 mm	–	669/863 lx ¹	MZA 224 N	113 003 000 - 005 555 58
2 x 39 WT16	Integrated electronic ballast	A = 960 mm x B = 220 mm	–	1096/1395 lx ¹	MZA 239 N	113 005 000 - 005 555 73
2 x 54 WT16	Integrated electronic ballast	A = 1260 mm x B = 220 mm	–	1546/1921 lx ¹	MZA 254 N	113 014 000 - 005 556 91

24 VDC

FITTED WITH	OPERATING DEVICE	DIMENSIONS	SPECIAL FEATURE	E_m / E_{max}^*	MODEL	ORDER NO.
2 x 11 WTC-SEL	Integrated electronic ballast	A = 340 mm x B = 300 mm	–	304/388 lx ¹	MZAC 211 S	112 997 000 - 005 555 06
1 x 24 WT16	Integrated electronic ballast	A = 660 mm x B = 180 mm	–	363/466 lx ¹	MZA 124 S	112 995 000 - 005 554 69
1 x 36 WT16	Integrated electronic ballast	A = 960 mm x B = 180 mm	–	601/766 lx ¹	MZA 139 S	112 996 000 - 005 554 84

* E_m = medium illuminance; E_{max} = maximum illuminance; ¹Measuring range 100 cm x 100 cm/Measuring distance 100 cm
Also available as an integrated machine luminaire

MACH LED

TRIED AND TESTED IN DAILY APPLICATIONS.



Technical progress makes everything more compact – including the inside of systems and machines. Often, there is not much space left to integrate the lighting. Thanks to its flexibility and its slimline housing that is available in various lengths with 1, 2, 3 and 4 LEDs, the new MACH LED is the perfect solution for such situations. Thanks to the individually adjustable beam direction by the use of side part A, the light is always where you need it – even if the LED luminaire cannot be directly mounted in the working area.

- Variants with narrow and wide angles of illumination
- Standard-compliant lighting for every lighting and room situation
- Variants with clear and satined screen
- Constantly high lighting quality in the long term
- Direct connection to 24 V without additional components
- Connection via M12 plug connector
- Ideal for high stress
- High system of protection
- Maintenance-free: LED life of up to 50,000 hours and more
- Unlimited functionality irrespective of frequent switching or fluctuations of mains voltage
- Resistance-tested with many cooling agents and lubricants



MACH LED with side part A



MACH LED with side part B (screw-down flange)

efficient *light*

Features

- 1, 2, 3 or 4 x HIGH POWER LED
- Color temperature neutral white 5,000 K
- Angle of illumination 30° (lens) with clear or 50° (reflector) with clear or satined screen
- Colorless anodized aluminum housing, 4 mm thick safety glass
- Screw-mounted (side part B) or mounted with various brackets from the accessories (side part A)
- Without switch
- System of protection IP67; class of protection III
- Supplied without mains lead, connection via M12-plug connector
- Various brackets, pre-assembled connection cables, customizable M12 sleeves, and operating devices to connect to the mains voltage as an accessory

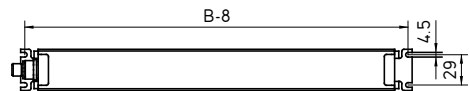
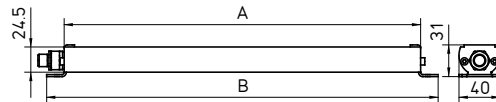
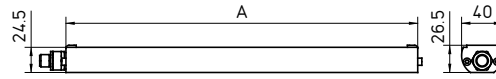

Integrated machine luminaires



Surface-mounted luminaires

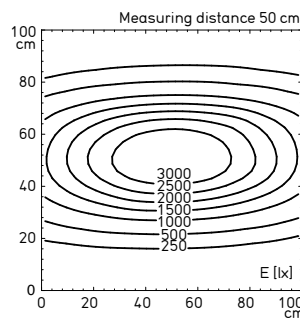

Illuminance based on the example 24 W with 30° lens

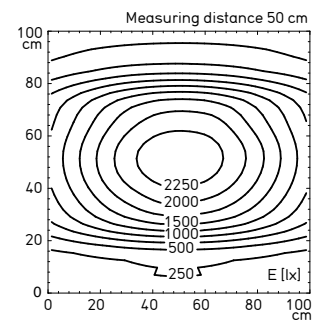

Illuminance based on the example 24 W with 50° reflector

20 – 28 VDC				cETLus			
CONSUMPTION	OPERATING DEVICE	DIMENSIONS	SPECIAL FEATURE	E_m/E_{max}^*	MODEL	ORDER NUMBER	
6 W	–	A = 182 mm	30° lens	295/1153 lx ¹	MTAL 1 S	112 567 041 - 004 886 06	
6 W	–	A = 182 mm B = 216 mm	30° lens, screw-down flange	295/1153 lx ¹	MTAL 1 S	112 567 000 - 005 482 48	
6 W	–	A = 182 mm B = 216 mm	50° reflector	297/782 lx ¹	MTAL 1 S	112 567 044 - 004 636 93	
6 W	–	A = 182 mm B = 216 mm	50° reflector, screw-down flange	297/782 lx ¹	MTAL 1 S	112 567 045 - 005 218 32	
NEW 6 W	–	A = 182 mm	50° reflector, satined screen	214/580 lx ¹	MTAL 1 S	112 567 000 - 005 701 17	
12 W	–	A = 357 mm	30° lens	530/1938 lx ¹	MTAL 2 S	112 567 055 - 004 760 03	
12 W	–	A = 357 mm B = 391 mm	30° lens, screw-down flange	530/1938 lx ¹	MTAL 2 S	112 567 000 - 005 482 51	
12 W	–	A = 357 mm	50° reflector	579/1458 lx ¹	MTAL 2 S	112 567 054 - 004 636 98	
12 W	–	A = 357 mm B = 391 mm	50° reflector, screw-down flange	579/1458 lx ¹	MTAL 2 S	112 567 056 - 005 209 31	
NEW 12 W	–	A = 357 mm	50° reflector, satined screen	439/1135 lx ¹	MTAL 2 S	112 567 000 - 005 701 20	
18 W	–	A = 532 mm	30° lens	805/2776 lx ¹	MTAL 3 S	112 567 065 - 005 051 96	
18 W	–	A = 532 mm B = 566 mm	30° lens, screw-down flange	805/2776 lx ¹	MTAL 3 S	112 567 000 - 005 482 54	
18 W	–	A = 532 mm	50° reflector	869/2090 lx ¹	MTAL 3 S	112 567 064 - 004 637 01	
18 W	–	A = 532 mm B = 566 mm	50° reflector, screw-down flange	869/2090 lx ¹	MTAL 3 S	112 567 066 - 005 209 42	
NEW 18 W	–	A = 532 mm	50° reflector, satined screen	628/1514 lx ¹	MTAL 3 S	112 567 000 - 005 701 24	
24 W	–	A = 707 mm	30° lens	1107/3477 lx ¹	MTAL 4 S	112 567 075 - 004 783 81	
24 W	–	A = 707 mm B = 741 mm	30° lens, screw-down flange	1107/3477 lx ¹	MTAL 4 S	112 567 000 - 005 482 57	
24 W	–	A = 707 mm	50° reflector	1077/2419 lx ¹	MTAL 4 S	112 567 074 - 004 644 16	
24 W	–	A = 707 mm B = 741 mm	50° reflector, screw-down flange	1077/2419 lx ¹	MTAL 4 S	112 567 076 - 004 637 06	
NEW 24 W	–	A = 707 mm	50° reflector, satined screen	852/1912 lx ¹	MTAL 4 S	112 567 000 - 005 701 27	

* E_m = Medium illuminance; E_{max} = Maximum illuminance; ¹ Measuring range 100 cm x 100 cm / Measuring distance 50 cm

MACH LED PRO

SUPERIOR LIGHTING THANKS TO LED: INCREDIBLY POWERFUL, INCREDIBLY FLAT.



The fact is: In the workrooms of almost all modern machines, there is hardly any space left. This is why Waldmann has developed MACH LED PRO, an extremely flat, variable machine luminaire that conforms to all standards thanks to the use of the latest LED technology. It was inspired by the established MACH LED platform. Once you have selected the right length, it is the perfect solution for many lighting tasks – irrespective of whether you need to light up a whole area or merely require focused lighting.

- Standard-compliant lighting for every lighting and room situation
- Variants with narrow and wide angles of illumination
- Constantly high lighting quality in the long term
- Direct connection to 24 V without additional components
- Ideal for high mechanical and thermal stress
- High system of protection
- Maintenance-free: LED life of up to 50,000 hours and more
- Unlimited functionality irrespective of frequent switching or fluctuations of mains voltage
- Resistance-tested with many cooling agents and lubricants



efficient^{light}

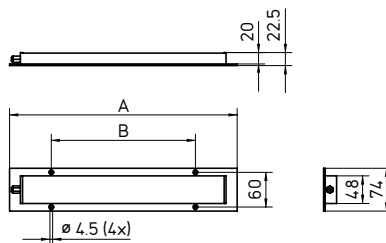

Integrated machine luminaires

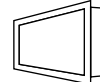

Surface-mounted luminaires

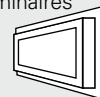

Features at a glance

- 1, 2, 3 or 4 x HIGH POWER LED
- Color temperature neutral white 5,000 K
- Direct illumination or 30° angle of illumination (lens)
- Aluminum colored anodized housing, 4 mm thick safety glass
- Screw-mounted
- Without switch
- System of protection IP67; class of protection III
- Supplied with 3 m mains lead and free stranded wires
- Driver to connect to the mains voltage as an accessory

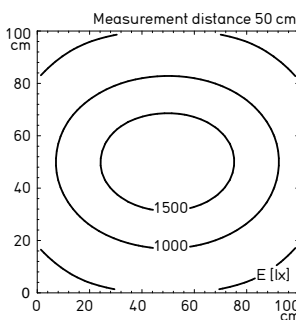

Illuminance based on the example of 24 W without lens (95°)

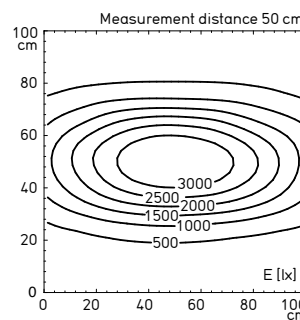

Illuminance based on the example of 24 W with 30° lens

20 – 28 VDC

CONSUMPTION	OPERATING DEVICE	DIMENSIONS	SPECIAL FEATURE	E_m / E_{max}^*	MODEL	ORDER NO.
6 W	–	A = 220 x 74 mm B = 125 mm (1x)	–	261/560 lx ¹	MUAL 1 S	112 571 022 - 000 821 86
6 W	–	A = 220 x 74 mm B = 125 mm (1x)	30° lens	333/1224 lx ¹	MUAL 1 S	112 571 020 - 000 790 42
12 W	–	A = 395 x 74 mm B = 250 mm (1x)	–	527/1065 lx ¹	MUAL 2 S	112 571 026 - 000 825 11
12 W	–	A = 395 x 74 mm B = 250 mm (1x)	30° lens	612/2186 lx ¹	MUAL 2 S	112 571 024 - 000 824 56
18 W	–	A = 570 x 74 mm B = 200 mm (2x)	–	758/1459 lx ¹	MUAL 3 S	112 571 032 - 000 828 20
18 W	–	A = 570 x 74 mm B = 200 mm (2x)	30° lens	922/3061 lx ¹	MUAL 3 S	112 571 030 - 000 827 88
24 W	–	A = 745 x 74 mm B = 250 mm (2x)	–	1001/1820 lx ¹	MUAL 4 S	112 571 036 - 000 828 46
24 W	–	A = 745 x 74 mm B = 250 mm (2x)	30° lens	1122/3429 lx ¹	MUAL 4 S	112 571 034 - 000 828 44

20 – 28 VAC

CONSUMPTION	OPERATING DEVICE	DIMENSIONS	SPECIAL FEATURE	E_m / E_{max}^*	MODEL	ORDER NO.
6 W	–	A = 220 x 74 mm B = 125 mm (1x)	–	261/560 lx ¹	MUAL 1 S	112 571 023 - 000 822 50
6 W	–	A = 220 x 74 mm B = 125 mm (1x)	30° lens	333/1224 lx ¹	MUAL 1 S	112 571 021 - 000 822 49
12 W	–	A = 395 x 74 mm B = 250 mm (1x)	–	527/1065 lx ¹	MUAL 2 S	112 571 027 - 000 826 35
12 W	–	A = 395 x 74 mm B = 250 mm (1x)	30° lens	612/2186 lx ¹	MUAL 2 S	112 571 025 - 000 826 32
18 W	–	A = 570 x 74 mm B = 200 mm (2x)	–	758/1459 lx ¹	MUAL 3 S	112 571 033 - 000 828 42
18 W	–	A = 570 x 74 mm B = 200 mm (2x)	30° lens	922/3061 lx ¹	MUAL 3 S	112 571 031 - 000 828 40
24 W	–	A = 745 x 74 mm B = 250 mm (2x)	–	1001/1820 lx ¹	MUAL 4 S	112 571 037 - 000 828 66
24 W	–	A = 745 x 74 mm B = 250 mm (2x)	30° lens	1122/3429 lx ¹	MUAL 4 S	112 571 035 - 000 828 63

* E_m = medium illuminance; E_{max} = maximum illuminance; ¹ Measuring range 100 cm x 100 cm / Measuring distance 50 cm

Also available as an integrated machine luminaire

FLAT LED

LED MEETS THE ART OF ENGINEERING.



It's not possible to integrate a luminaire in the machine wall? In such cases, FLAT LED provides a convincing solution. To avoid significantly changing the interference contour, even in compact workrooms, this luminaire compresses the maximum luminous power in the flattest possible space: With a combination of six HIGH POWER LEDs and Waldmann's special lens technology, which evenly disperses the beam over an entire area.

- Constantly high lighting quality in the long term
- For strong, wide-range and even lighting
- Excellent glare-free features
- Direct connection to 24 V without additional components
- For tough application conditions
- High system of protection
- Resistance-tested with many cooling agents and lubricants
- Maintenance-free: LED life of up to 50,000 hours and more



efficient *light*

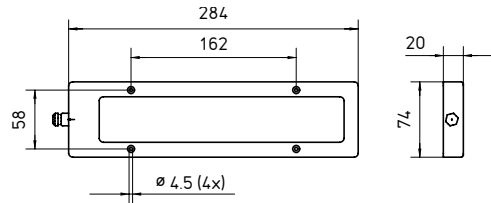

Integrated machine luminaires



Surface-mounted luminaires



Features at a glance

- 6 x HIGH POWER LED
- Color temperature daylight white 6,500 K
- 60° angle of illumination
- Black aluminum anodized housing, 4 mm thick safety glass
- Screw-mounted
- Without switch
- System of protection IP67 and IPX9K in accordance with DIN 40050-9; class of protection III
- Supplied with 3 m mains lead and free stranded wires
- Bracket angle to adjust the luminaire and driver to connect to the mains voltage as accessories

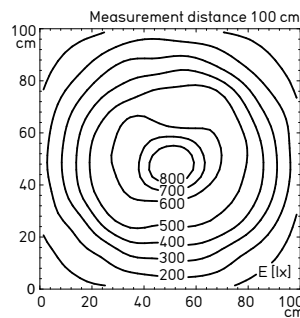

Illuminance 13 W

10 – 40 VDC							cETLus
CONSUMPTION	OPERATING DEVICE	DIMENSIONS	SPECIAL FEATURE	E_m/E_{max}^*	MODEL	ORDER NUMBER	
13 W	–	284 x 74 mm	–	347/869 lx ¹	MYAL 6 S	112 560 000 - 000 030 69	

10 – 30 VAC						
CONSUMPTION	OPERATING DEVICE	DIMENSIONS	SPECIAL FEATURE	E_m/E_{max}^*	MODEL	ORDER NUMBER
13 W	–	284 x 74 mm	–	347/869 lx ¹	MYAL 6 S	112 560 002 - 000 062 72

* E_m = Medium illuminance; E_{max} = Maximum illuminance; ¹ Measuring range 100 cm x 100 cm/Measuring distance 100 cm
 Also available as an integrated machine luminaire

SPOT LED

POWERFUL LIGHT IN MINI FORMAT.



You could hardly imagine a more compact light with this much power: The round, robust aluminum housing of the SPOT LED combines three LEDs, which provide either spot or area lighting, depending on the particular variant. And they're absolutely flicker-free. This means that it is not just the design of the integrated LED spotlight that is a feast for the eyes.

- Permanently high lighting quality
- Variants with narrow and wide angles of illumination
- Maintenance-free: LED life of up to 50,000 hours and more
- Direct connection to 24 V without additional components
- For tough applications
- Resistance-tested with many cooling agents and lubricants
- High system of protection
- Unlimited functionality irrespective of frequent switching or fluctuations of mains voltage



efficient *light*

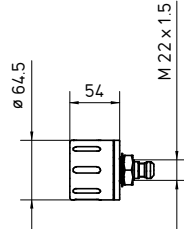

Integrated machine luminaires



Surface-mounted luminaires



Features at a glance

- 3 x HIGH POWER LED
- Color temperature daylight white 5,700 K
- 10° or 40° angle of illumination
- Black aluminum anodized housing, 3 mm thick safety glass
- Screw-mounted
- Without switch
- System of protection IP67; class of protection III
- Supplied with 3 m mains lead and free stranded wires
- Driver to connect to the mains voltage as an accessory

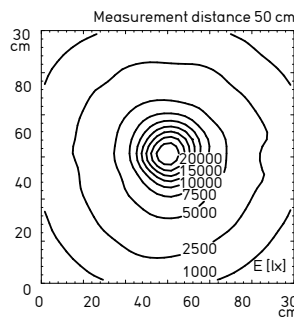

Illuminance with 10° lens

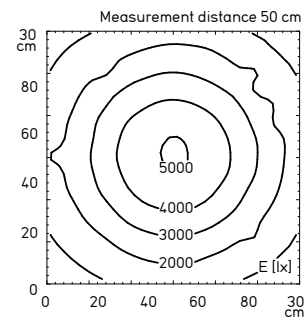

Illuminance with 40° lens

16 – 30 VAC / 16 – 40 VDC

CONSUMPTION	OPERATING DEVICE	DIMENSIONS	SPECIAL FEATURE	E_m / E_{max}^*	MODEL	ORDER NUMBER
6 W	–	∅ 64.5 mm	10° lens	3358/22350 lx ¹	MCAYL 3 S	112 461 001 - 000 830 05
6 W	–	∅ 64.5 mm	40° lens	2539/5095 lx ¹	MCAYL 3 S	112 461 003 - 000 878 71

* E_m = Medium illuminance; E_{max} = Maximum illuminance; ¹ Measuring range 30 cm x 30 cm / Measuring distance 50 cm
 Also available as an arm-mounted luminaire, flexible tube luminaire, pivoting-head luminaire and integrated machine luminaire

HEAD LED

GOOD THINGS COME IN SMALL PACKAGES.

The working area is the heart of every machine tool and thus deserves a special spotlight: Waldmann's smallest light ever. Thanks to its compact dimensions, HEAD LED always fits into the tool area and generates a powerful, precise LED spot light thanks to Waldmann's cleverly devised lens.

- Maximum power from an impressively small light
- Ideal for high mechanical stress
- Variants with narrow and wide angles of illumination
- Maintenance-free: LED life of up to 50,000 hours and more
- High system of protection
- Resistance-tested with many cooling agents and lubricants





efficient *light*

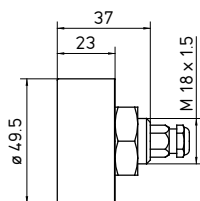

Integrated machine luminaires

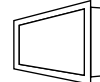

Surface-mounted luminaires

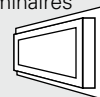

Features at a glance

- 1 x HIGH POWER LED
- Color temperature daylight white 5,600 K
- Direct illumination or 70° angle of illumination
- Black aluminum anodized housing, 4 mm thick safety glass
- Screw-mounted
- Without switch
- System of protection IP67; class of protection III
- Supplied with 0.15 m mains lead and M12 connection
- Driver to connect to the mains voltage and ready-made M12 plug socket as an accessory

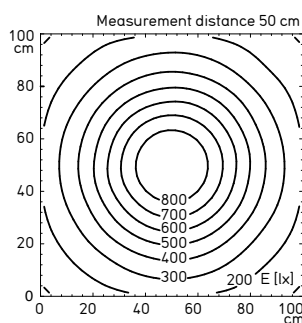

Illuminance based on the example without lens (100°)

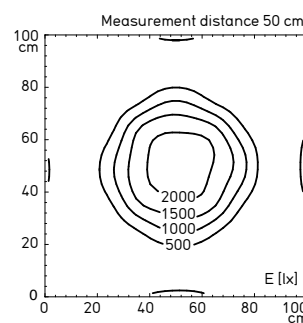

Illuminance based on the example with 70° lens

CONNECTION TO AC ONSTANT POWER SOURCE WITH 700 MA

CONSUMPTION	OPERATING DEVICE	DIMENSIONS	SPECIAL FEATURE	E_m / E_{max}^*	MODEL	ORDER NO.
11 W	-	ø 49.5 mm	-	398/889 lx ¹	MCAYL 4 S	112 554 000 - 000 031 65
11 W	-	ø 49.5 mm	70° lens	459/2304 lx ¹	MCAYL 4 S	112 554 001 - 000 057 58

* E_m = medium illuminance; E_{max} = maximum illuminance; ¹ Measuring range 100 cm x 100 cm/Measuring distance 50 cm

For cooling purposes, the luminaire must be attached to a metal surface.

Detailed data sheet available for download at www.waldmann-industrial.com

SLIM LED

A CUSTOMIZED AREA LIGHT.



In the realm of peripheral machine equipment, beyond the influence of coolants and lubricants, there's often little space available for strong lighting. The slimline profile of the SLIM LED is a convincing solution when you need to integrate a light in a tight space. And in case the LED light doesn't have the ideal angle of incidence: the adjustable variant can help.

- Variants with an adjustable beam direction
- Direct connection to 24 V without additional components
- Maintenance-free: LED life of up to 50,000 hours and more
- Unlimited functionality irrespective of frequent switching



SLIM LED +/- 45° adjustable



SLIM LED with fixed brackets

efficient^{light}

Features at a glance

- 6, 12, 24, 36 or 48 x LED
- Color temperature daylight white 5,400 K
- Direct beam without/with clear screen or glare-free with satine screen
- Aluminum colored anodized housing/ acrylic screen
- Screw-mounted to fixed brackets or +/-45° adjustable mounting profile
- Without switch
- System of protection IP67; class of protection III
- Supplied with 3 m mains lead and free stranded wires
- Ballasts to connect to the mains voltage as an accessory

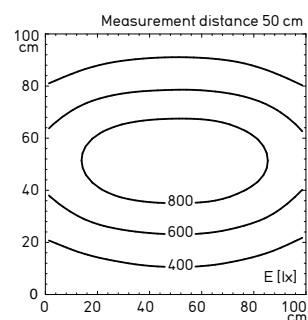
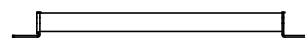
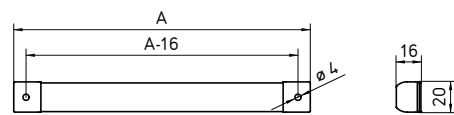
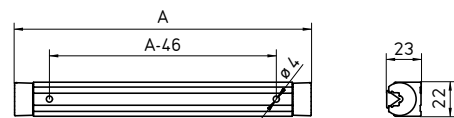

Illuminance based on the example of 29 W with clear screen



Integrated
machine
luminaires



Surface-
mounted
luminaires



23 – 25VDC						cETLus
CONSUMPTION	OPERATING DEVICE	DIMENSIONS	SPECIAL FEATURE	E_m/E_{max}^*	MODEL	ORDER NO.
4 W	–	A = 196 x 22 mm	Clear screen, adjustable	95/206 lx ¹	LIQ 6	112 544 000 - 000 013 28
4 W	–	A = 196 x 22 mm	Satine screen, adjustable	89/206 lx ¹	LIQ 6	112 544 005 - 000 111 00
4 W	–	A = 196 x 22 mm	Adjustable	98/212 lx ¹	LIQ 6	112 544 010 - 000 111 01
4 W	–	A = 196 x 20 mm	Clear screen	95/206 lx ¹	LIQ 6	112 545 000 - 000 013 51
4 W	–	A = 196 x 20 mm	Satine screen	89/206 lx ¹	LIQ 6	112 545 005 - 000 111 20
4 W	–	A = 196 x 20 mm	–	98/212 lx ¹	LIQ 6	112 545 010 - 000 111 21
8 W	–	A = 336 x 22 mm	Clear screen, adjustable	184/401 lx ¹	LIQ 12	112 544 001 - 000 110 81
8 W	–	A = 336 x 22 mm	Satine screen, adjustable	169/391 lx ¹	LIQ 12	112 544 006 - 000 110 88
8 W	–	A = 336 x 22 mm	Adjustable	191/411 lx ¹	LIQ 12	112 544 011 - 000 111 02
8 W	–	A = 336 x 20 mm	Clear screen	184/401 lx ¹	LIQ 12	112 545 001 - 000 111 25
8 W	–	A = 336 x 20 mm	Satine screen	169/391 lx ¹	LIQ 12	112 545 006 - 000 111 28
8 W	–	A = 336 x 20 mm	–	191/411 lx ¹	LIQ 12	112 545 011 - 000 111 29
15 W	–	A = 616 x 22 mm	Clear screen, adjustable	360/699 lx ¹	LIQ 24	112 544 002 - 000 110 82
15 W	–	A = 616 x 22 mm	Satine screen, adjustable	336/691 lx ¹	LIQ 24	112 544 007 - 000 110 85
15 W	–	A = 616 x 22 mm	Adjustable	377/726 lx ¹	LIQ 24	112 544 012 - 000 111 03
15 W	–	A = 616 x 20 mm	Clear screen	360/699 lx ¹	LIQ 24	112 545 002 - 000 111 30
15 W	–	A = 616 x 20 mm	Satine screen	336/691 lx ¹	LIQ 24	112 545 007 - 000 111 31
15 W	–	A = 616 x 20 mm	–	377/726 lx ¹	LIQ 24	112 545 012 - 000 111 32
22 W	–	A = 896 x 22 mm	Clear screen, adjustable	491/872 lx ¹	LIQ 36	112 544 003 - 000 110 83
22 W	–	A = 896 x 22 mm	Satine screen, adjustable	449/833 lx ¹	LIQ 36	112 544 008 - 000 110 86
22 W	–	A = 896 x 22 mm	Adjustable	507/900 lx ¹	LIQ 36	112 544 013 - 000 111 04
22 W	–	A = 896 x 20 mm	Clear screen	491/872 lx ¹	LIQ 36	112 545 003 - 000 111 33
22 W	–	A = 896 x 20 mm	Satine screen	449/833 lx ¹	LIQ 36	112 545 008 - 000 111 34
22 W	–	A = 896 x 20 mm	–	507/900 lx ¹	LIQ 36	112 545 013 - 000 111 35
29 W	–	A = 1176 x 22 mm	Clear screen, adjustable	578/946 lx ¹	LIQ 48	112 544 004 - 000 110 84
29 W	–	A = 1176 x 22 mm	Satine screen, adjustable	535/908 lx ¹	LIQ 48	112 544 009 - 000 110 87
29 W	–	A = 1176 x 22 mm	Adjustable	604/973 lx ¹	LIQ 48	112 544 014 - 000 111 05
29 W	–	A = 1176 x 20 mm	Clear screen	578/946 lx ¹	LIQ 48	112 545 004 - 000 111 36
29 W	–	A = 1176 x 20 mm	Satine screen	535/908 lx ¹	LIQ 48	112 545 009 - 000 111 37
29 W	–	A = 1176 x 20 mm	–	604/973 lx ¹	LIQ 48	112 545 014 - 000 111 38

* E_m = medium illuminance; E_{max} = maximum illuminance; ¹ Measuring range 100 cm x 100 cm / Measuring distance 50 cm

ONE LED

ALWAYS KEEPS ITS COOL.



Less space and high temperatures – in some machines, you are faced with a lot of problems. Where most lights often fail, ONE LED shows its true capabilities: Thanks to its minimalist, but very robust construction, the corresponding design is even resistant to very high temperatures. It is precisely because of this that ONE LED can be compactly integrated in the tool area and illuminates it with high-power LED technology.

- Maximum power from an impressively small light
- Precise positioning of the beam
- Maintenance-free: LED life of up to 50,000 hours and more
- Direct connection to 24 V without additional components
- Safe, fast and easy integration
- Variants for ambient temperatures up to 50° C (variant with safety glass)
- High system of protection
- Safe functionality irrespective of frequent switching or fluctuations of mains voltage
- Resistance-tested with many cooling agents and lubricants (variant with safety glass)



ONE LED with +/- 90° adjustable bracket sheet

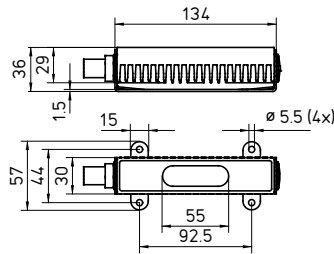

ONE LED for fixed assembly

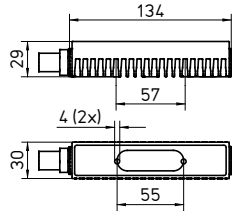

efficient *light*

Features at a glance

- 1 x HIGH POWER LED
- Color temperature neutral white 5,000 K
- Direct beam
- Aluminum housing, 4 mm thick safety glass or acrylic screen
- Screw-mounted to the housing or +/-90° adjustable bracket sheet
- Without switch
- System of protection IP54 (acrylic screen) or IP67 (safety glass); class of protection III
- Supplied without mains lead, tool-free connection via express connector
- Driver to connect to the mains voltage as an accessory

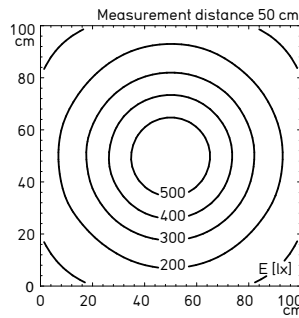

Illuminance 6 W

Integrated machine luminaires



Surface-mounted luminaires



















20 – 28 VDC							cETLus
CONSUMPTION	OPERATING DEVICE	DIMENSIONS	SPECIAL FEATURE	E_m / E_{max}^*	MODEL	ORDER NO.	
6 W	–	162.5 x 57 mm	PMMA screen, adjustable	261/571 lx ¹	MVAL 1 S	112 887 027 - 000 760 50	
6 W	–	162.5 x 57 mm	Glass screen, adjustable	261/571 lx ¹	MVAL 1 S	112 887 037 - 000 760 65	
6 W	–	162.5 x 30 mm	PMMA screen	261/571 lx ¹	MVAL 1 S	112 887 024 - 000 760 49	
6 W	–	162.5 x 30 mm	Glass screen	261/571 lx ¹	MVAL 1 S	112 887 034 - 000 760 59	

* E_m = medium illuminance; E_{max} = maximum illuminance; ¹ Measuring range 100 cm x 100 cm/Measuring distance 50 cm

TUBE LUMINAIRES

Waterproof tube luminaires are particularly suitable for the illumination of machine tools. The extensive tube luminaire range offers customized lighting, based on the task and the environment.



RL 40 E (integrated electronic ballast)		  IP67	50 - 51	Integrated machine luminaires 
RL 70 E (integrated electronic ballast)		  IP67	52 - 55	Surface-mounted luminaires 
RL 70 H (integrated electronic ballast behind the lamp)		  IP67	56 - 57	Tube luminaires 
AWD		   IP67	58 - 59	

RL 40 E (WITH INTEGRATED ELECTRONIC BALLAST)

ROBUST IN USE, SLIMLINE DESIGN.



Tube luminaires are the established solution for providing wide-range lighting of larger workrooms. The powerful illumination of the RL 40 E luminaire is more than capable of meeting this task. Furthermore, despite its integrated ballast, it is very slim, robust and durable.

- With high luminous power and modern energy-saving technology
- With integrated electronic ballast
- Extremely long life and reliability thanks to the careful processing of premium materials
- Side-parts made of fiberglass-reinforced polyamide
- High system of protection
- Resistance-tested with many cooling agents and lubricants

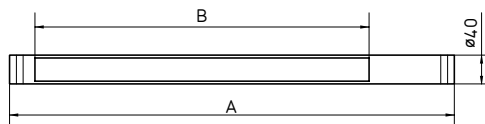

Integrated machine luminaires

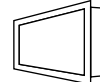

Surface-mounted luminaires

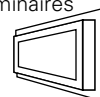

Tube luminaires



Features at a glance

- T16 fluorescent lamp
- Color temperature neutral white 4,000 K
- Direct beam
- Luminaire body of clear acrylic
- Integration by various brackets from the accessories
- Without switch
- System of protection IP67; class of protection I
- Supplied without mains lead with screwed cable gland
- Various brackets as accessories

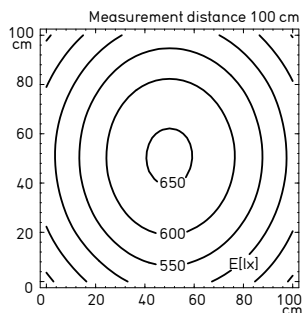

Illuminance based on the example 1 x 54 W

230 – 240 V, 50/60 HZ

FITTED WITH	OPERATING DEVICE	DIMENSIONS	SPECIAL FEATURE	E_m / E_{max}^*	MODEL	ORDER NO.
1 x 24 WT16	Integrated electronic ballast	A = 1003 mm B = 549 mm	–	285/364 lx ¹	RL40 E - 124	112 231 020 - 000 491 49
1 x 39 WT16	Integrated electronic ballast	A = 1303 mm B = 849 mm	–	378/476 lx ¹	RL40 E - 139	112 232 020 - 000 492 26
1 x 54 WT16	Integrated electronic ballast	A = 1654 mm B = 1149 mm	–	533/654 lx ¹	RL40 E - 154	112 233 020 - 000 492 84

* E_m = medium illuminance; E_{max} = maximum illuminance; ¹ Measuring range 100 cm x 100 cm / Measuring distance 100 cm

RL 70 E (WITH INTEGRATED ELECTRONIC BALLAST)

EVERYTHING IN ONE PREMIUM PACKAGE.

Maximum, wide-range lighting of the inside of the machine – maybe in a glare-free design? The established answer to this is RL 70 E. Quite simply because this tube luminaire does not require an external ballast and is also not afraid of the toughest application conditions.

- With high luminous power and modern energy-saving technology
- In accordance with EN-1837 glare-free variants with parabolic louvers
- Integrated electronic ballast
- Extremely long life and reliability thanks to premium materials
- Bayonet connection of fiberglass-reinforced polyamide
- High system of protection
- Resistance-tested with many cooling agents and lubricants





Integrated
machine
luminaires



Surface-
mounted
luminaires



Tube
luminaires



RL 70 E in design without parabolic louver

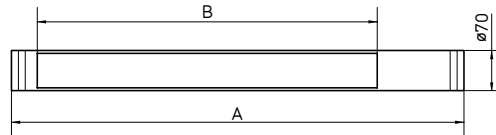

Features at a glance

- TC-L and TC-SEL compact fluorescent lamp or T16, T26 fluorescent lamp(s)
- Color temperature neutral white 4,000 K
- Direct beam or glare-free thanks to aluminumized parabolic louver
- Luminaire body of clear acrylic or borosilicate glass
- Integration by various brackets from the accessories
- Without switch
- System of protection IP67; class of protection I
- Supplied without mains lead with screwed cable gland
- Various brackets as accessories

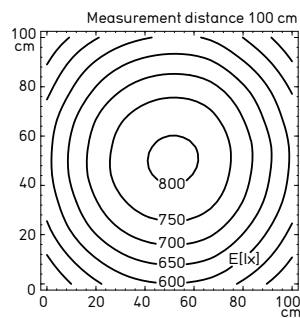

Illuminance based on the example
2 x 39 W without parabolic louver

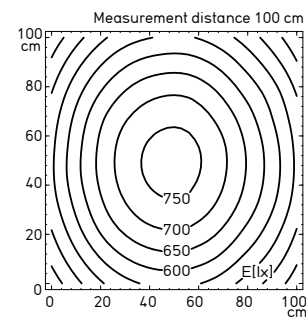

Illuminance based on the example
2 x 39 W with parabolic louver

230 – 240 V, 50/60 HZ

FITTED WITH	OPERATING DEVICE	DIMENSIONS		SPECIAL FEATURE	E_m / E_{max}^*	MODEL	ORDER NO.
1 x 11 WTC-SEL	Integr. electronic ballast	A = 483 mm	B = 198 mm	Acrylic	135/171 lx ¹	RL70CE-111	111 921 000 - 000 637 57
1 x 11 WTC-SEL	Integr. electronic ballast	A = 483 mm	B = 198 mm	Acrylic; parabolic louver	120/157 lx ¹	RL70CE-111	111 921 010 - 000 637 56
1 x 11 WTC-SEL	Integr. electronic ballast	A = 483 mm	B = 198 mm	Borosilicate glass	120/157 lx ¹	RL70CE-111	111 921 001 - 000 637 59
1 x 11 WTC-SEL	Integr. electronic ballast	A = 483 mm	B = 198 mm	Borosilicate glass; parabolic louver	120/157 lx ¹	RL70CE-111	111 921 011 - 000 637 58
1 x 18 WT26	Integr. electronic ballast	A = 916 mm	B = 597 mm	Acrylic	207/262 lx ¹	RL70E-118	111 841 000 - 000 679 40
1 x 18 WT26	Integr. electronic ballast	A = 916 mm	B = 597 mm	Acrylic; parabolic louver	172/222 lx ¹	RL70E-118	111 841 010 - 000 688 91
1 x 18 WT26	Integr. electronic ballast	A = 916 mm	B = 597 mm	Borosilicate glass	207/262 lx ¹	RL70E-118	111 841 001 - 000 687 31
1 x 18 WT26	Integr. electronic ballast	A = 916 mm	B = 597 mm	Borosilicate glass; parabolic louver	172/222 lx ¹	RL70E-118	111 841 011 - 000 868 78
1 x 36 WT26	Integr. electronic ballast	A = 1724 mm	B = 1200 mm	Acrylic	410/490 lx ¹	RL70E-136	111 821 000 - 000 661 92
1 x 36 WT26	Integr. electronic ballast	A = 1724 mm	B = 1200 mm	Acrylic; parabolic louver	348/420 lx ¹	RL70E-136	111 821 010 - 000 695 45
1 x 36 WT26	Integr. electronic ballast	A = 1724 mm	B = 1200 mm	Borosilicate glass	410/490 lx ¹	RL70E-136	111 821 001 - 000 632 28
1 x 36 WT26	Integr. electronic ballast	A = 1724 mm	B = 1200 mm	Borosilicate glass; parabolic louver	348/420 lx ¹	RL70E-136	111 821 011 - 000 851 07
1 x 58 WT26	Integr. electronic ballast	A = 2027 mm	B = 1548 mm	Acrylic	497/693 lx ²	RL70E-158	111 911 000 - 000 651 95
1 x 58 WT26	Integr. electronic ballast	A = 2027 mm	B = 1548 mm	Acrylic; parabolic louver	425/620 lx ²	RL70E-158	111 911 010 - 000 695 46
1 x 58 WT26	Integr. electronic ballast	A = 2027 mm	B = 1548 mm	Borosilicate glass	497/693 lx ²	RL70E-158	111 911 001 - 000 651 94
1 x 58 WT26	Integr. electronic ballast	A = 2027 mm	B = 1548 mm	Borosilicate glass; parabolic louver	425/620 lx ²	RL70E-158	111 911 011 - 000 651 96

100/120/230 V, 50/60 HZ

FITTED WITH	OPERATING DEVICE	DIMENSIONS		SPECIAL FEATURE	E_m / E_{max}^*	MODEL	ORDER NO.
1 x 18 WTC-L	Integr. electronic ballast	A = 486 mm	B = 198 mm	Acrylic	160/205 lx ¹	RL70CE-118	111 371 000 - 000 570 24
1 x 18 WTC-L	Integr. electronic ballast	A = 486 mm	B = 198 mm	Acrylic; parabolic louver	154/211 lx ¹	RL70CE-118	111 371 010 - 000 570 23
1 x 18 WTC-L	Integr. electronic ballast	A = 486 mm	B = 198 mm	Borosilicate glass	160/205 lx ¹	RL70CE-118	111 371 001 - 000 570 26
1 x 18 WTC-L	Integr. electronic ballast	A = 486 mm	B = 198 mm	Borosilicate glass; parabolic louver	154/211 lx ¹	RL70CE-118	111 371 011 - 000 570 25
1 x 24 WTC-L	Integr. electronic ballast	A = 572 mm	B = 293 mm	Acrylic	259/333 lx ¹	RL70CE-124	111 381 000 - 000 570 29
1 x 24 WTC-L	Integr. electronic ballast	A = 572 mm	B = 293 mm	Acrylic; parabolic louver	220/313 lx ¹	RL70CE-124	111 381 004 - 000 570 28
1 x 24 WTC-L	Integr. electronic ballast	A = 572 mm	B = 293 mm	Borosilicate glass	259/333 lx ¹	RL70CE-124	111 381 003 - 000 570 31
1 x 24 WTC-L	Integr. electronic ballast	A = 572 mm	B = 293 mm	Borosilicate glass; parabolic louver	220/313 lx ¹	RL70CE-124	111 381 005 - 000 570 30

220 – 240 V, 50/60 HZ

FITTED WITH	OPERATING DEVICE	DIMENSIONS		SPECIAL FEATURE	E_m / E_{max}^*	MODEL	ORDER NO.
1 x 36 WTC-L	Integr. electronic ballast	A = 827 mm	B = 363 mm	Acrylic	337/437 lx ¹	RL70CE-136	112 009 000 - 000 661 19
1 x 36 WTC-L	Integr. electronic ballast	A = 827 mm	B = 363 mm	Acrylic; parabolic louver	327/450 lx ¹	RL70CE-136	112 009 010 - 000 661 17
1 x 36 WTC-L	Integr. electronic ballast	A = 827 mm	B = 363 mm	Borosilicate glass	337/437 lx ¹	RL70CE-136	112 009 001 - 000 661 18
1 x 36 WTC-L	Integr. electronic ballast	A = 827 mm	B = 363 mm	Borosilicate glass; parabolic louver	327/450 lx ¹	RL70CE-136	112 009 011 - 000 661 16
2 x 39 WT16	Integr. electronic ballast	A = 1475 mm	B = 829 mm	Acrylic	641/805 lx ¹	RL70E-239	112 501 000 - 000 975 72
2 x 39 WT16	Integr. electronic ballast	A = 1475 mm	B = 829 mm	Acrylic; parabolic louver	577/765 lx ¹	RL70E-239	112 501 010 - 000 975 74
2 x 39 WT16	Integr. electronic ballast	A = 1475 mm	B = 829 mm	Borosilicate glass	641/805 lx ¹	RL70E-239	112 501 001 - 000 975 73
2 x 39 WT16	Integr. electronic ballast	A = 1475 mm	B = 829 mm	Borosilicate glass; parabolic louver	577/765 lx ¹	RL70E-239	112 501 011 - 000 975 75
2 x 54 WT16	Integr. electronic ballast	A = 1744 mm	B = 1048 mm	Borosilicate glass	923/1427 lx ²	RL70E-254	112 180 001 - 000 863 00
2 x 54 WT16	Integr. electronic ballast	A = 1744 mm	B = 1048 mm	Borosilicate glass; parabolic louver	698/1185 lx ²	RL70E-254	112 180 011 - 000 863 01

110 – 230 V, 50/60 HZ

cETLus

FITTED WITH	OPERATING DEVICE	DIMENSIONS		SPECIAL FEATURE	E_m / E_{max}^*	MODEL	ORDER NO.
1 x 40 WTC-L	Integr. electronic ballast	A = 1040 mm	B = 530 mm	Borosilicate glass	442/563 lx ¹	RL70CE-140	112 331 003 - 000 307 81
1 x 40 WTC-L	Integr. electronic ballast	A = 1040 mm	B = 530 mm	Borosilicate glass; parabolic louver	400/552 lx ¹	RL70CE-140	112 331 005 - 000 307 75

* E_m = medium illuminance; E_{max} = maximum illuminance¹ Measuring range 100 cm x 100 cm / Measuring distance 100 cm; ² Measuring range 100 cm x 200 cm / Measuring distance 100 cm



Integrated
machine
luminaires



Surface-
mounted
luminaires



Tube
luminaires



24 VDC							
FITTED WITH	OPERATING DEVICE	DIMENSIONS		SPECIAL FEATURE	E_m / E_{max}^*	MODEL	ORDER NO.
1 x 18 WTC-L	Integr. electronic ballast	A=524 mm	B=212 mm	Acrylic	159/205 lx ¹	RL70CE-118	112 370 000 - 000 841 57
1 x 18 WTC-L	Integr. electronic ballast	A=524 mm	B=212 mm	Acrylic; parabolic louver	152/208 lx ¹	RL70CE-118	112 370 010 - 000 841 68
1 x 18 WTC-L	Integr. electronic ballast	A=524 mm	B=212 mm	Borosilicate glass	159/205 lx ¹	RL70CE-118	112 370 001 - 000 841 61
1 x 18 WTC-L	Integr. electronic ballast	A=524 mm	B=212 mm	Borosilicate glass; parabolic louver	152/208 lx ¹	RL70CE-118	112 370 011 - 000 841 69
1 x 18 W T26	Integr. electronic ballast	A=919 mm	B=597 mm	Acrylic	207/262 lx ¹	RL70E-118	111 690 000 - 000 634 06
1 x 18 W T26	Integr. electronic ballast	A=919 mm	B=597 mm	Acrylic; parabolic louver	172/222 lx ¹	RL70E-118	111 690 010 - 000 674 71
1 x 18 W T26	Integr. electronic ballast	A=919 mm	B=597 mm	Borosilicate glass	207/262 lx ¹	RL70E-118	111 690 001 - 000 634 08
1 x 18 W T26	Integr. electronic ballast	A=919 mm	B=597 mm	Borosilicate glass; parabolic louver	172/222 lx ¹	RL70E-118	111 690 011 - 000 634 07
1 x 24 WTC-L	Integr. electronic ballast	A=639 mm	B=317 mm	Acrylic	259/333 lx ¹	RL70CE-124	111 440 000 - 000 571 73
1 x 24 WTC-L	Integr. electronic ballast	A=639 mm	B=317 mm	Acrylic; parabolic louver	220/313 lx ¹	RL70CE-124	111 440 010 - 000 571 74
1 x 24 WTC-L	Integr. electronic ballast	A=639 mm	B=317 mm	Borosilicate glass	259/333 lx ¹	RL70CE-124	111 440 001 - 000 571 75
1 x 24 WTC-L	Integr. electronic ballast	A=639 mm	B=317 mm	Borosilicate glass; parabolic louver	220/313 lx ¹	RL70CE-124	111 440 011 - 000 571 76
1 x 36 WTC-L	Integr. electronic ballast	A=747 mm	B=364 mm	Acrylic	337/437 lx ¹	RL70CE-136	111 450 000 - 000 640 46
1 x 36 WTC-L	Integr. electronic ballast	A=747 mm	B=364 mm	Acrylic; parabolic louver	327/450 lx ¹	RL70CE-136	111 450 010 - 000 644 22
1 x 36 WTC-L	Integr. electronic ballast	A=747 mm	B=364 mm	Borosilicate glass	337/437 lx ¹	RL70CE-136	111 450 001 - 000 571 77
1 x 36 WTC-L	Integr. electronic ballast	A=747 mm	B=364 mm	Borosilicate glass; parabolic louver	271/352 lx ¹	RL70CE-136	111 450 011 - 000 571 78
1 x 36 W T26	Integr. electronic ballast	A=1532 mm	B=1210 mm	Acrylic	410/490 lx ¹	RL70E-136	111 730 000 - 000 599 87
1 x 36 W T26	Integr. electronic ballast	A=1532 mm	B=1210 mm	Acrylic; parabolic louver	348/420 lx ¹	RL70E-136	111 730 010 - 000 599 90
1 x 36 W T26	Integr. electronic ballast	A=1532 mm	B=1210 mm	Borosilicate glass	410/490 lx ¹	RL70E-136	111 730 001 - 000 599 91
1 x 36 W T26	Integr. electronic ballast	A=1532 mm	B=1210 mm	Borosilicate glass; parabolic louver	348/420 lx ¹	RL70E-136	111 730 011 - 000 599 88
1 x 58 W T26	Integr. electronic ballast	A=1850 mm	B=1541 mm	Acrylic	497/693 lx ²	RL70E-158	112 170 000 - 000 867 80
1 x 58 W T26	Integr. electronic ballast	A=1850 mm	B=1541 mm	Acrylic; parabolic louver	425/620 lx ²	RL70E-158	112 170 010 - 000 887 53
1 x 58 W T26	Integr. electronic ballast	A=1850 mm	B=1541 mm	Borosilicate glass	497/693 lx ²	RL70E-158	112 170 001 - 000 855 33
1 x 58 W T26	Integr. electronic ballast	A=1850 mm	B=1541 mm	Borosilicate glass; parabolic louver	425/620 lx ²	RL70E-158	112 170 011 - 000 865 01

24 VAC, 50/60 HZ							
FITTED WITH	OPERATING DEVICE	DIMENSIONS		SPECIAL FEATURE	E_m / E_{max}^*	MODEL	ORDER NO.
1 x 18 WTC-L	Integr. electronic ballast	A=524 mm	B=212 mm	Acrylic	159/205 lx ¹	RL70CE-118	112 369 000 - 000 841 94
1 x 18 WTC-L	Integr. electronic ballast	A=524 mm	B=212 mm	Acrylic; parabolic louver	152/208 lx ¹	RL70CE-118	112 369 010 - 000 841 95
1 x 18 WTC-L	Integr. electronic ballast	A=524 mm	B=212 mm	Borosilicate glass	159/205 lx ¹	RL70CE-118	112 369 001 - 000 842 04
1 x 18 WTC-L	Integr. electronic ballast	A=524 mm	B=212 mm	Borosilicate glass; parabolic louver	152/208 lx ¹	RL70CE-118	112 369 011 - 000 841 97
1 x 18 W T26	Integr. electronic ballast	A=919 mm	B=597 mm	Acrylic	207/262 lx ¹	RL70E-118	111 650 000 - 000 630 29
1 x 18 W T26	Integr. electronic ballast	A=919 mm	B=597 mm	Acrylic; parabolic louver	172/222 lx ¹	RL70E-118	111 650 010 - 000 815 94
1 x 18 W T26	Integr. electronic ballast	A=919 mm	B=597 mm	Borosilicate glass	207/262 lx ¹	RL70E-118	111 650 001 - 000 630 30
1 x 18 W T26	Integr. electronic ballast	A=919 mm	B=597 mm	Borosilicate glass; parabolic louver	172/222 lx ¹	RL70E-118	111 650 011 - 000 630 31
1 x 24 WTC-L	Integr. electronic ballast	A=639 mm	B=317 mm	Acrylic	259/333 lx ¹	RL70CE-124	111 410 000 - 000 571 56
1 x 24 WTC-L	Integr. electronic ballast	A=639 mm	B=317 mm	Acrylic; parabolic louver	220/313 lx ¹	RL70CE-124	111 410 010 - 000 571 57
1 x 24 WTC-L	Integr. electronic ballast	A=639 mm	B=317 mm	Borosilicate glass	259/333 lx ¹	RL70CE-124	111 410 001 - 000 571 58
1 x 24 WTC-L	Integr. electronic ballast	A=639 mm	B=317 mm	Borosilicate glass; parabolic louver	220/313 lx ¹	RL70CE-124	111 410 011 - 000 571 59
1 x 36 WTC-L	Integr. electronic ballast	A=747 mm	B=364 mm	Acrylic	337/437 lx ¹	RL70CE-136	111 420 000 - 000 571 61
1 x 36 WTC-L	Integr. electronic ballast	A=747 mm	B=364 mm	Acrylic; parabolic louver	327/450 lx ¹	RL70CE-136	111 420 010 - 000 571 62
1 x 36 WTC-L	Integr. electronic ballast	A=747 mm	B=364 mm	Borosilicate glass	337/437 lx ¹	RL70CE-136	111 420 001 - 000 571 64
1 x 36 WTC-L	Integr. electronic ballast	A=747 mm	B=364 mm	Borosilicate glass; parabolic louver	327/450 lx ¹	RL70CE-136	111 420 011 - 000 571 67
1 x 36 W T26	Integr. electronic ballast	A=1532 mm	B=1210 mm	Acrylic	410/490 lx ¹	RL70E-136	111 720 000 - 000 599 78
1 x 36 W T26	Integr. electronic ballast	A=1532 mm	B=1210 mm	Acrylic; parabolic louver	348/420 lx ¹	RL70E-136	111 720 010 - 000 599 77
1 x 36 W T26	Integr. electronic ballast	A=1532 mm	B=1210 mm	Borosilicate glass	410/490 lx ¹	RL70E-136	111 720 001 - 000 599 80
1 x 36 W T26	Integr. electronic ballast	A=1532 mm	B=1210 mm	Borosilicate glass; parabolic louver	348/420 lx ¹	RL70E-136	111 720 011 - 000 599 79

* E_m = medium illuminance; E_{max} = maximum illuminance

¹ Measuring range 100 cm x 100 cm/Measuring distance 100 cm; ² Measuring range 100 cm x 200 cm/Measuring distance 100 cm

RL 70 H (ELECTRONIC BALLAST BEHIND THE LAMP)

CONVINCING LIGHT ALONG ITS ENTIRE LENGTH.



Two become one: the RL 70 H intelligently combines the advantages of an integrated luminaire with the advantages of a separate ballast. It practically illuminates the entire tube length without requiring any further components.

- With high luminous power and modern energy-saving technology
- Light output along almost the entire length of the luminaire
- In accordance with EN-1837 glare-free variants with parabolic louvers
- With integrated electronic ballast
- Extremely long life and reliability thanks to premium materials
- Bayonet connection of fiberglass-reinforced polyamide
- High system of protection
- Resistance-tested with many cooling agents and lubricants

230 – 240 V, 50/60 HZ

FITTED WITH	OPERATING DEVICE	DIMENSIONS		SPECIAL FEATURE	E_m / E_{max}^*	MODEL	ORDER NO.
1 x 36 WTC-L	Integr. electronic ballast	A = 585 mm	B = 395 mm	Acrylic	280/354 lx ¹	RL70CE-136 H	112 472 000 - 000 908 25
1 x 36 WTC-L	Integr. electronic ballast	A = 585 mm	B = 395 mm	Acrylic; parabolic louver	271/352 lx ¹	RL70CE-136 H	112 472 010 - 000 878 15
1 x 36 WTC-L	Integr. electronic ballast	A = 585 mm	B = 395 mm	Borosilicate glass	280/354 lx ¹	RL70CE-136 H	112 472 001 - 000 908 24
1 x 36 WTC-L	Integr. electronic ballast	A = 585 mm	B = 395 mm	Borosilicate glass; parabolic louver	271/352 lx ¹	RL70CE-136 H	112 472 011 - 000 908 03
2 x 36 WTC-L	Integr. electronic ballast	A = 1065 mm	B = 790 mm	Acrylic	421/515 lx ¹	RL70CE-236 H	112 449 000 - 000 813 04
2 x 36 WTC-L	Integr. electronic ballast	A = 1065 mm	B = 790 mm	Acrylic; parabolic louver	409/510 lx ¹	RL70CE-236 H	112 449 010 - 000 828 68
2 x 36 WTC-L	Integr. electronic ballast	A = 1065 mm	B = 790 mm	Borosilicate glass	421/515 lx ¹	RL70CE-236 H	112 449 001 - 000 813 05
2 x 36 WTC-L	Integr. electronic ballast	A = 1065 mm	B = 790 mm	Borosilicate glass; parabolic louver	409/510 lx ¹	RL70CE-236 H	112 449 011 - 000 813 32

110/230 V, 50/60 HZ

cETLus

FITTED WITH	OPERATING DEVICE	DIMENSIONS		SPECIAL FEATURE	E_m / E_{max}^*	MODEL	ORDER NO.
1 x 36 WTC-L	Integr. electronic ballast	A = 585 mm	B = 395 mm	Acrylic	280/354 lx ¹	RL70CE-136 H	619 063 007 - 000 831 50
1 x 36 WTC-L	Integr. electronic ballast	A = 585 mm	B = 395 mm	Acrylic; parabolic louver	256/350 lx ¹	RL70CE-136 H	619 063 017 - 000 831 49
1 x 36 WTC-L	Integr. electronic ballast	A = 585 mm	B = 395 mm	Borosilicate glass	280/354 lx ¹	RL70CE-136 H	619 063 001 - 000 109 61
1 x 36 WTC-L	Integr. electronic ballast	A = 585 mm	B = 395 mm	Borosilicate glass; parabolic louver	256/350 lx ¹	RL70CE-136 H	619 063 011 - 000 059 22

* E_m = medium illuminance; E_{max} = maximum illuminance; ¹ Measuring range 100 cm x 100 cm / Measuring distance 100 cm



RL 70 H in design without parabolic louvre

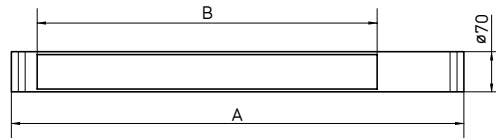

Features at a glance

- TC-L compact fluorescent lamp(s)
- Color temperature neutral white 4,000 K
- Direct beam or glare-free thanks to aluminized parabolic louvre
- Luminaire body of clear acrylic or borosilicate glass
- Integration by various brackets from the accessories
- Without switch
- System of protection IP67; class of protection I
- Supplied without mains lead with screwed cable gland
- Various brackets as accessories

Integrated machine luminaires



Surface-mounted luminaires



Tube luminaires

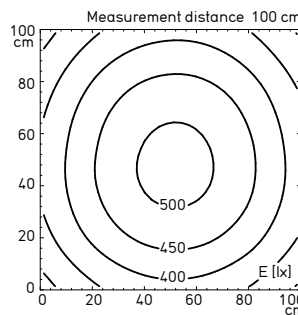

Illuminance based on the example 2 x 36 W without parabolic louvre (112 449 001 - 000 813 05)

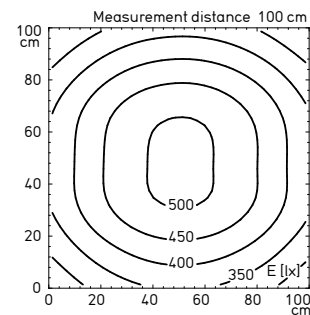

Illuminance based on the example 2 x 36 W with parabolic louvre (112 449 011 - 000 813 32)

100 – 250 V, 50/60 HZ

FITTED WITH	OPERATING DEVICE	DIMENSIONS	SPECIAL FEATURE	E_m / E_{max}^*	MODEL	ORDER NO.
1 x 24 WTC-L	Integr. electronic ballast	A=495 mm B=311 mm	Acrylic	242/305 lx ¹	RL70CE-124 H	112 911 000 - 004 887 10
1 x 24 WTC-L	Integr. electronic ballast	A=495 mm B=311 mm	Acrylic; parabolic louvre	207/281 lx ¹	RL70CE-124 H	112 911 010 - 004 888 15
1 x 24 WTC-L	Integr. electronic ballast	A=495 mm B=311 mm	Borosilicate glass	242/305 lx ¹	RL70CE-124 H	112 911 001 - 004 887 13
1 x 24 WTC-L	Integr. electronic ballast	A=495 mm B=311 mm	Borosilicate glass; parabolic louvre	207/281 lx ¹	RL70CE-124 H	112 911 011 - 004 888 18

100 – 277 V, 50/60 HZ cETLus-variants (not CE-conform)

FITTED WITH	OPERATING DEVICE	DIMENSIONS	SPECIAL FEATURE	E_m / E_{max}^*	MODEL	ORDER NO.
1 x 24 WTC-L	Integr. electronic ballast	A=495 mm B=311 mm	Acrylic	242/305 lx ¹	RL70CE-124 H	112 913 000 - 004 887 07
1 x 24 WTC-L	Integr. electronic ballast	A=495 mm B=311 mm	Acrylic; parabolic louvre	207/281 lx ¹	RL70CE-124 H	112 913 010 - 004 887 29
1 x 24 WTC-L	Integr. electronic ballast	A=495 mm B=311 mm	Borosilicate glass	242/305 lx ¹	RL70CE-124 H	112 913 001 - 004 887 16
1 x 24 WTC-L	Integr. electronic ballast	A=495 mm B=311 mm	Borosilicate glass; parabolic louvre	207/281 lx ¹	RL70CE-124 H	112 913 011 - 004 887 35

24 VAC/DC

FITTED WITH	OPERATING DEVICE	DIMENSIONS	SPECIAL FEATURE	E_m / E_{max}^*	MODEL	ORDER NO.
1 x 24 WTC-L	Integr. electronic ballast	A=475 mm B=331 mm	Acrylic	204/259 lx ¹	RL70CE-124 H	112 470 004 - 000 929 98
1 x 24 WTC-L	Integr. electronic ballast	A=475 mm B=331 mm	Acrylic; parabolic louvre	196/257 lx ¹	RL70CE-124 H	112 470 006 - 000 930 00
1 x 24 WTC-L	Integr. electronic ballast	A=475 mm B=331 mm	Borosilicate glass	204/259 lx ¹	RL70CE-124 H	112 470 005 - 000 929 99
1 x 24 WTC-L	Integr. electronic ballast	A=475 mm B=331 mm	Borosilicate glass; parabolic louvre	196/257 lx ¹	RL70CE-124 H	112 470 007 - 000 930 01
1 x 36 WTC-L	Integr. electronic ballast	A=585 mm B=395 mm	Acrylic	258/322 lx ¹	RL70CE-136 H	112 411 000 - 000 939 95
1 x 36 WTC-L	Integr. electronic ballast	A=585 mm B=395 mm	Acrylic; parabolic louvre	271/352 lx ¹	RL70CE-136 H	112 411 010 - 000 939 96
1 x 36 WTC-L	Integr. electronic ballast	A=585 mm B=395 mm	Borosilicate glass	258/322 lx ¹	RL70CE-136 H	112 411 001 - 000 940 03
1 x 36 WTC-L	Integr. electronic ballast	A=585 mm B=395 mm	Borosilicate glass; parabolic louvre	271/352 lx ¹	RL70CE-136 H	112 411 011 - 000 940 04

* E_m = medium illuminance; E_{max} = maximum illuminance; ¹ Measuring range 100 cm x 100 cm / Measuring distance 100 cm

AWD

A STRONG LIGHT IN TOUGH CONDITIONS.



The AWD is the ideal tube luminaire for lighting up tight spaces: its dimensions are short and compact, which doesn't prevent it from being a powerful, energy-efficient luminaire.

- With options for fluorescent lamps or LED technology
- Only one luminaire bracket is required for mounting it
- Extremely long life and reliability thanks to premium materials
- High system of protection
- Resistance-tested with many cooling agents and lubricants



AWDL 1

efficient *light*

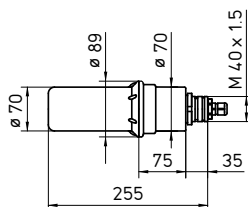

Integrated machine luminaires

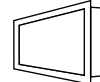

Surface-mounted luminaires

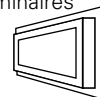

Tube luminaires



Features at a glance

- TC-DEL compact fluorescent lamp or 1 x HIGH POWER LED
- Color temperature neutral white 4,000 K
- Direct beam or glare-free thanks to aluminized parabolic louver (TC-DEL)
- Luminaire body of borosilicate glass
- Integration by screws or brackets from the accessories
- Without switch
- System of protection IP67; class of protection II (TC-DEL) or class of protection III (LED)
- Supplied without mains lead with screwed cable gland
- Bracket as accessory

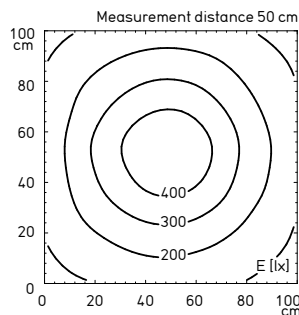

Illuminance AWDL 1

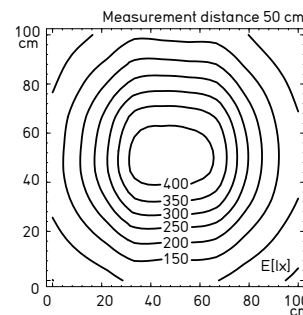

Illuminance AWDCE with parabolic louver

24 VDC

CONSUMPTION	OPERATING DEVICE	DIMENSIONS	SPECIAL FEATURE	E_m/E_{max}^*	MODEL	ORDER NUMBER
NEW 5.5 W LED	–	ø 70 mm	Borosilicate glass; reflector	234/476 lx ¹	AWDL 1	112 950 000 - 005 215 46

230 – 240 V, 50/60 HZ

FITTED WITH	OPERATING DEVICE	DIMENSIONS	SPECIAL FEATURE	E_m/E_{max}^*	MODEL	ORDER NUMBER
1 x 18 W TC-DEL	Integrated electronic ballast	ø 70 mm	Borosilicate glass	289/598 lx ¹	AWDCE 118	112 154 001 - 000 836 34
1 x 18 W TC-DEL	Integrated electronic ballast	ø 70 mm	Borosilicate glass; parabolic louver	189/425 lx ¹	AWDCE 118	112 154 011 - 000 836 35

24 VDC



































FITTED WITH	OPERATING DEVICE	DIMENSIONS	SPECIAL FEATURE	E_m/E_{max}^*	MODEL	ORDER NUMBER
1 x 18 W TC-DEL	Integrated electronic ballast	ø 70 mm	Borosilicate glass	289/598 lx ¹	AWDCE 118	112 153 001 - 000 836 32
1 x 18 W TC-DEL	Integrated electronic ballast	ø 70 mm	Borosilicate glass; parabolic louver	189/425 lx ¹	AWDCE 118	112 153 011 - 000 836 33

* E_m = Medium illuminance; E_{max} = Maximum illuminance; ¹ Measuring range 100 cm x 100 cm / Measuring distance 50 cm

ARM-MOUNTED LUMINAIRES

Arm-mounted luminaires provide a wide-range light and above all precisely adjustable lighting of machines, workshops, laboratories and assembly workplaces.



SPOT LED	 -30% energy		  IP65 or IP40	62 - 63
HSW 20			  IP65	64 - 65
HSW 75			  IP65	66 - 67
MHW			  IP54	68 - 69
HI 20			   IP20	70 - 71
HG			  IP20	72 - 73
HGL			  IP20	74 - 75
WD 211			  IP54	76 - 77
TANEO	 NEW		  IP20	78 - 81
STE 111			  IP20	82 - 83
SN/SNE			  IP20	84 - 85

Integrated machine luminaires



Surface-mounted luminaires



Tube luminaires



Arm-mounted luminaires

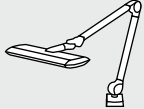

SPOT LED



HIGHLY CONCENTRATED LIGHT.



LED

The SPOT LED has three combined LEDs and thus an extremely high luminous intensity as spot or area lighting. But that's not the only flexibility it boasts: In combination with the arm that stretches out into the room, it is no problem lighting every square-millimeter of even the largest working areas.

- Variants with narrow and wide angles of illumination
- Big working radius – ideal for large work spaces, machines or systems
- Comfort and safety thanks to absolutely even and flicker-free light
- Low energy consumption

- Without heat development in the beam direction
- No danger of accidents due to stroboscopic effect
- Maintenance-free: LED life of up to 50,000 hours and more
- Convenient switching on and off from your working position

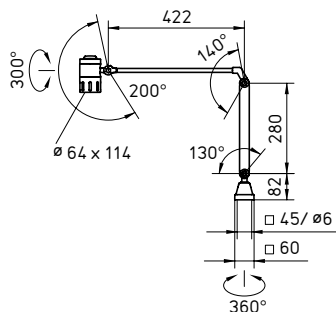

Integrated machine luminaires

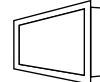

Surface-mounted luminaires

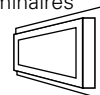

Tube luminaires



Arm-mounted luminaires



Features at a glance

- 3 x HIGH POWER LED
- Color temperature daylight white 5,700 K
- 10° or 40° angle of illumination
- Black aluminum anodized housing, 3 mm thick safety glass
- Arm relieved by friction
- With switch in the luminaire head
- System of protection IP65 (without mains plug) or IP40 (with mains plug, luminaire head IP65); class of protection III (without mains plug) or II (with mains plug)
- Supplied with 3 m mains lead with free stranded wires or with mains plug type CEE 7/16 (Euro plug), BS 1363 and NEMA 1-15P
- Various fastenings as accessories

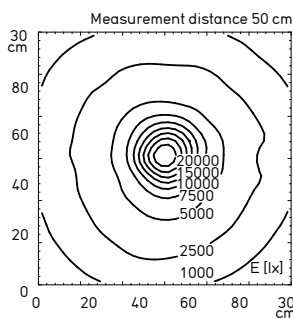

Illuminance with 10° lens

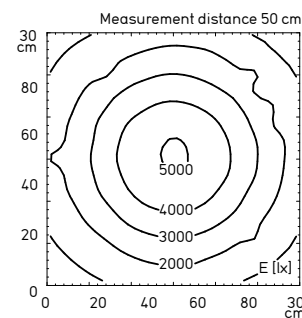

Illuminance with 40° lens

CONSUMPTION	OPERATING DEVICE	CONNECTED LOAD	SPECIAL FEATURE	E_m / E_{max}^*	MODEL	ORDER NO.
7 W	Mains plug	100 – 240 V, 50/60 Hz	10° lens	3358/22350 lx ¹	MCBFL 3 N	112 463 007 - 000 916 62
7 W	Mains plug	100 – 240 V, 50/60 Hz	40° lens	2539/5095 lx ¹	MCBFL 3 N	112 463 009 - 000 919 54
6 W	–	16 – 30 VAC/16 – 40 VDC	10° lens	3358/22350 lx ¹	MCBFL 3 S	112 463 001 - 000 916 60
6 W	–	16 – 30 VAC/16 – 40 VDC	40° lens	2539/5095 lx ¹	MCBFL 3 S	112 463 003 - 000 919 35

* E_m = medium illuminance; E_{max} = maximum illuminance; ¹ Measuring range 30 cm x 30 cm/Measuring distance 50 cm

Also available as a flexible-tube luminaire, pivoting-head luminaire, integrated machine luminaire and surface-mounted luminaire

HSW 20

EXCELLENT LIGHT FOR THE HIGHEST DEMANDS.



When luminous intensity is combined with a large radius of action, it can be used in almost every workshop and machine. On the one hand, because the strong focused light with selected characteristics provides the best lighting of the working area. On the other hand, because the solid arm enables rapid and easy positioning.

- Brilliant halogen light
- Glare-free thanks to louver
- Variants with narrow and wide angles of illumination
- High system of protection
- Easy to reach switch that can be operated with one hand
- Easy changing of illuminant
- Reduced temperature in the beam direction thanks to twin glass screen

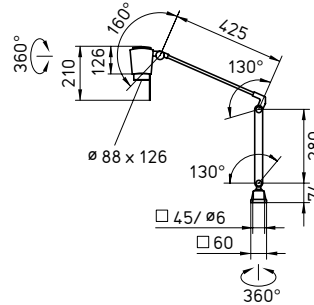

Integrated machine luminaires



Surface-mounted luminaires



Tube luminaires



Arm-mounted luminaires

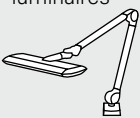

Features at a glance

- Halogen lamp
- Color temperature warm white 2,800 K (23 W) or 3,000 K (20 W)
- Glare-free thanks to metal louver, angle of illumination 10° or 36°
- Luminaire head of special black plastic, twin glass screen
- Arm relieved by friction
- With switch in the luminaire head
- System of protection IP65; class of protection I (without transformer) or II (with transformer)
- Supplied with 1.5 m mains lead with free stranded wires or plug type CEE 7/16 (Euro plug) for mains variant
- Various fastenings and magnifier (5 diopeters) as accessories

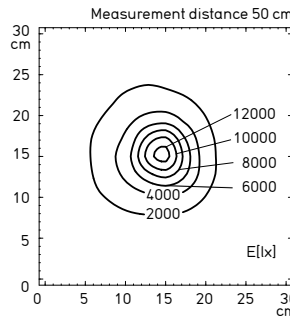

Illuminance with 10° angle of illumination (112 042 000 - 000 781 95)

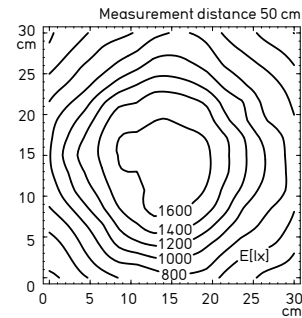

Illuminance with 36° angle of illumination (112 042 038 - 000 781 96)

FITTED WITH	OPERATING DEVICE	CONNECTED LOAD	SPECIAL FEATURE	E_m / E_{max}^*	MODEL	ORDER NO.
1 x 20 W	Integrated transformer	230 V, 50/60 Hz	10° angle of illumination	1295/12740 lx ¹	HSW 20	112 042 000 - 000 781 95
1 x 20 W	Integrated transformer	230 V, 50/60 Hz	36° angle of illumination	959/1698 lx ¹	HSW 20	112 042 038 - 000 781 96
1 x 23 W	–	24 VAC/DC	10° angle of illumination	1568/14550 lx ¹	HSW 20	112 043 010 - 000 782 14
1 x 20 W	–	12 VAC/DC	10° angle of illumination	1295/12740 lx ¹	HSW 20	112 043 000 - 000 782 10
1 x 20 W	–	12 VAC/DC	36° angle of illumination	959/1698 lx ¹	HSW 20	112 043 012 - 000 782 11

* E_m = medium illuminance; E_{max} = maximum illuminance; ¹ Measuring range 30 cm x 30 cm/Measuring distance 50 cm
 Also available as a flexible-tube luminaire and pivoting-head luminaire

HSW 75

THE FULL POWER OF LIGHT.



The precisely focused, very powerful, glare-free halogen light of the HSW 75 is not only ideal from a lighting perspective. The easy handling of the flexible and solid arm construction of this machine luminaire also makes it very easy to adjust

the luminaire head as desired.

- Strong, glare-free spot light
- High system of protection

- Heat protection jacket
- Easy to reach switch that can be operated with one hand
- Easy changing of illuminant thanks to bayonet connection

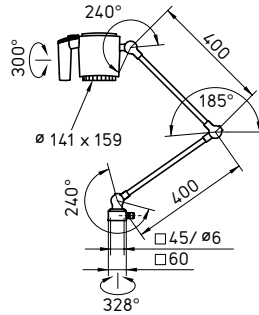

Features at a glance

- Halogen lamp
- Color temperature warm white 3,000 K
- Glare-free thanks to metal louver
- Black luminaire head of aluminum and plastic, glass screen
- Arm relieved by friction
- With switch in the luminaire head
- System of protection IP65; class of protection II (with transformer) or III (without transformer)
- Supplied without mains lead
- Various fastenings as accessories

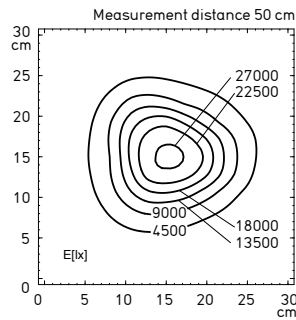

Illuminance 1 x 75 W
(112 186 000 - 000 051 82)

Integrated machine luminaires



Surface-mounted luminaires



Tube luminaires



Arm-mounted luminaires

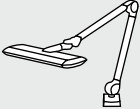

FITTED WITH	OPERATING DEVICE	CONNECTED LOAD	SPECIAL FEATURE	E_m / E_{max}^*	MODEL	ORDER NO.
1 x 75 W	Integrated transformer	230 V, 50/60 Hz	–	5052/27570 lx ¹	HSW 75	112 186 000 - 000 051 82
1 x 75 W	–	24 VAC/DC	–	4964/26680 lx ¹	HSW 75	112 185 010 - 000 052 46
1 x 75 W	–	12 VAC/DC	–	5052/27570 lx ¹	HSW 75	112 185 000 - 000 051 80

* E_m = medium illuminance; E_{max} = maximum illuminance; ¹ Measuring range 30 cm x 30 cm / Measuring distance 50 cm
Also available as a pivoting-head luminaire

MHW

FANCY-FREE FLOODLIGHT.

A machine arm-mounted luminaire not only has to provide the right light with as much flexibility as possible. It also has to withstand quite a bit of stress. MHW can do both these things very well.

Its high-powered halogen luminaire head is fitted with a stable arm that functions perfectly even after years of extreme stress and is adjustable within the blink of an eye.

- Movable
- Bright
- Robust
- High system of protection



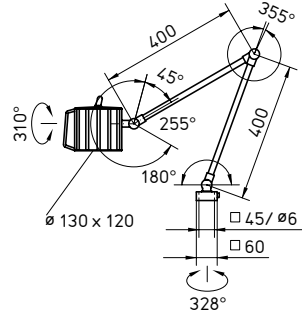

Features at a glance

- Halogen lamp
- Color temperature warm white 3,000 K
- Direct beam
- Aluminum colored anodized housing, glass screen
- Arm relieved by friction
- With switch in the luminaire head
- System of protection IP54; class of protection III
- Supplied without mains lead
- Various fastenings and transformers to connect to the mains voltage as an accessory

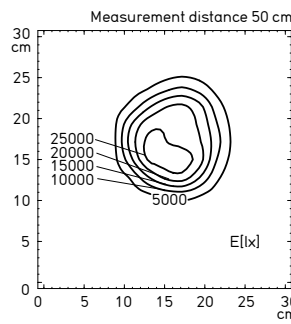

Illuminance 1 x 60 W

Integrated machine luminaires



Surface-mounted luminaires



Tube luminaires



Arm-mounted luminaires

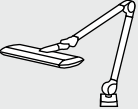

FITTED WITH	OPERATING DEVICE	CONNECTED LOAD	SPECIAL FEATURE	E_m / E_{max}^*	MODEL	ORDER NO.
1 x 60 W	-	24 VAC/DC	-	3341/27230 lx ¹	MHW 60	110 950 000 - 000 037 18

* E_m = medium illuminance; E_{max} = maximum illuminance; ¹ Measuring range 30 cm x 30 cm / Measuring distance 50 cm
 Also available as a pivoting-head luminaire

HI 20

INDIVIDUAL LIGHT FOR INDIVIDUAL NEEDS.



Why is an arm-mounted luminaire so variable? Because it can be moved from many sides and easily brought into the right position. The HI 20 has a trump card up its sleeve when it comes to versatility: Thanks to the availability of various designs, the radiation characteristic can be ideally adjusted to the task at hand. Together with a high luminous power, these properties turn the HI 20 into a universal task luminaire.

- Versatile uses
- Brilliant halogen light
- Easy and fast positioning
- Bright
- Heat protection jacket
- Easy, tool-free changing of lamp
- Convenient switching on and off from your working position
- Variants with narrow and wide angles of illumination
- Long life cycle of the lamp

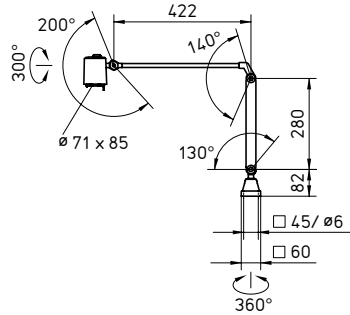

Integrated machine luminaires



Surface-mounted luminaires



Tube luminaires



Arm-mounted luminaires



Features at a glance

- Halogen lamp
- Color temperature warm white 2,800 K (23 W) or 3,000 K (20 W)
- 10°, 24°, 36° or 60° angle of illumination
- Black luminaire head of aluminum and plastic, glass screen
- Arm relieved by friction
- With switch in the luminaire head
- System of protection IP20; class of protection III (without transformer) or I (with transformer)
- Supplied with 1.5 m mains lead with free stranded wires or plug type CEE 7/7 (shock-proof plug) for mains variant
- Various fastenings and magnifier (4 diopters) as accessories

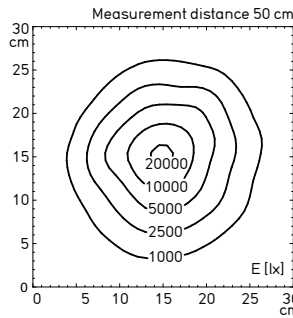

Illuminance with 10° angle of illumination (112 376 000 - 000 608 35)

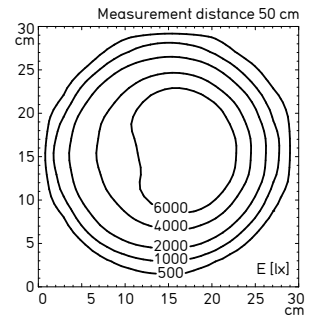

Illuminance with 24° angle of illumination (112 376 001 - 000 676 09)

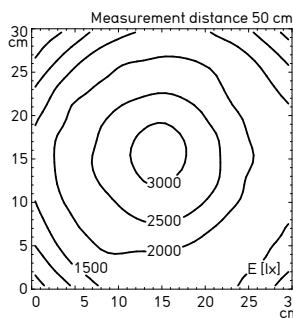

Illuminance with 36° angle of illumination (112 376 002 - 000 683 22)

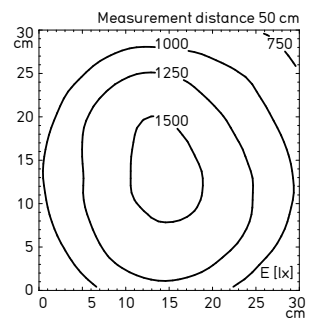

Illuminance with 60° angle of illumination (112 376 003 - 000 683 23)

FITTED WITH	OPERATING DEVICE	CONNECTED LOAD	SPECIAL FEATURE	E_m / E_{max}^*	MODEL	ORDER NO.
1 x 20 W	Integrated transformer	230 V, 50/60 Hz	10° angle of illumination	2268/23200 lx ¹	HIBF 20 N	112 376 000 - 000 608 35
1 x 20 W	Integrated transformer	230 V, 50/60 Hz	24° angle of illumination	2504/7375 lx ¹	HIBF 20 N	112 376 001 - 000 676 09
1 x 20 W	Integrated transformer	230 V, 50/60 Hz	36° angle of illumination	1970/3126 lx ¹	HIBF 20 N	112 376 002 - 000 683 22
1 x 20 W	Integrated transformer	230 V, 50/60 Hz	60° angle of illumination	1182/1598 lx ¹	HIBF 20 N	112 376 003 - 000 683 23
1 x 20 W	–	12 VAC/DC	24° angle of illumination	2504/7375 lx ¹	HIBF 20 S	112 377 005 - 000 683 28
1 x 23 W	–	24 VAC/DC	10° angle of illumination	1619/14398 lx ¹	HIBF 20 S	112 377 008 - 000 608 53
1 x 23 W	–	24 VAC/DC	24° angle of illumination	1683/7082 lx ¹	HIBF 20 S	112 377 009 - 000 903 11
1 x 23 W	–	24 VAC/DC	36° angle of illumination	1553/3055 lx ¹	HIBF 20 S	112 377 012 - 000 903 34

* E_m = medium illuminance; E_{max} = maximum illuminance; ¹ Measuring range 30 cm x 30 cm / Measuring distance 50 cm

Also available as a flexible-tube luminaire and pivoting-head luminaire

HG

BEST LIGHT – FOCUSED, GLARE-FREE LIGHTING.

The HG arm-mounted luminaire made of high-quality, long-lasting materials is a highly versatile halogen lamp. It is the right choice for every purpose, not least because it is far superior in terms of luminous intensity and ergonomics.

- Universal uses
- Very bright
- Glare-free
- Heat protection jacket



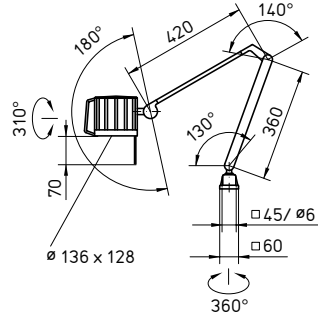

Features at a glance

- Halogen lamp
- Color temperature warm white 3,000 K
- Glare-free thanks to metal louver
- Black luminaire head of aluminum and plastic, glass screen
- Arm relieved by friction
- With switch in the arm
- System of protection IP20; class of protection I
- Supplied with 1.5 m mains lead with plug type CEE 7/7 (shock-proof plug)
- Various fastenings as accessories

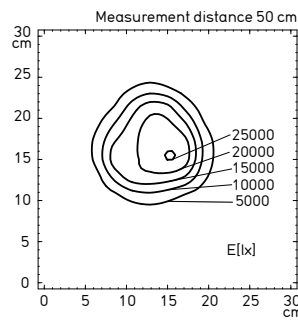

Illuminance 1 x 55 W

Integrated machine luminaires



Surface-mounted luminaires



Tube luminaires



Arm-mounted luminaires

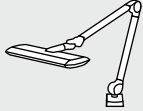

FITTED WITH	OPERATING DEVICE	CONNECTED LOAD	SPECIAL FEATURE	E_m/E_{max} *	MODEL	ORDER NO.
1 x 55 W	Integrated transformer	230 V, 50/60 Hz	–	2933/25050 lx ¹	HG 70	110 041 000 - 000 485 64

* E_m = medium illuminance; E_{max} = maximum illuminance; ¹ Measuring range 30 cm x 30 cm / Measuring distance 50 cm

HGL

UNCOMPROMISING STRENGTH.



Thanks to its extremely flexible arm, housing with heat protection. the HGL halogen luminaire ensures optimum adjustment of the light in every situation. The excellent handling is supported by an ergonomically shaped

- Very bright
- Glare-free in accordance with occupational safety criteria
- Heat protection jacket

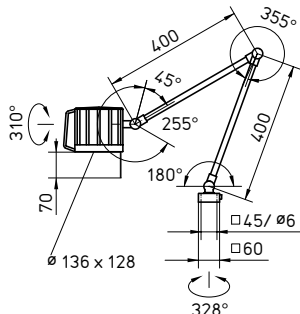

Features at a glance

- Halogen lamp
- Color temperature warm white 3,000 K
- Glare-free thanks to metal louver
- Black luminaire head of aluminum and plastic, glass screen
- Arm relieved by friction
- With switch in the luminaire head
- System of protection IP20; class of protection III
- Supplied without mains lead
- Various fastenings and transformers to connect to the mains voltage as an accessory

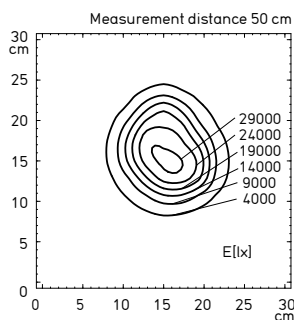

Illuminance based on the example 1 x 60 W

Integrated machine luminaires

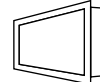

Surface-mounted luminaires

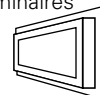

Tube luminaires



Arm-mounted luminaires



FITTED WITH	OPERATING DEVICE	CONNECTED LOAD	SPECIAL FEATURE	E_m / E_{max}^*	MODEL	ORDER NO.
1 x 60 W	–	24 VAC/DC	–	3243/29780 lx ¹	HGL 70	100 570 000 - 000 479 28
1 x 55 W	–	12 VAC/DC	–	2933/25050 lx ¹	HGL 70	100 570 010 - 000 596 58

* E_m = medium illuminance; E_{max} = maximum illuminance; ¹ Measuring range 30 cm x 30 cm/Measuring distance 50 cm
Also available as a pivoting-head luminaire

WD 211

LONG LIFE CYCLE GUARANTEED.



An even area lighting of large work spaces and workpieces makes a decisive contribution to ergonomics at the workplace. This task is impeccably performed by the universal luminaire WD 211 with two fluorescent lamps. Furthermore, it is so robust that liquids, dust and chips in the air cannot damage it even after it

has been in permanent use for years.

- Robust and versatile machine luminaire
- Metal luminaire head
- Large radius of action
- Durable mechanism

- High system of protection
- Low energy consumption

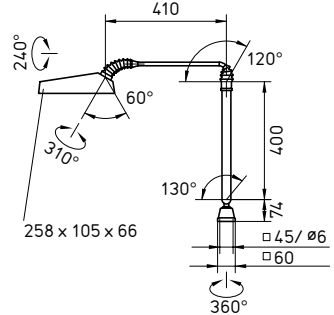

Features at a glance

- TC-L compact fluorescent lamps
- Color temperature neutral white 4,000 K
- Glare-free thanks to matt screen
- Light gray painted aluminum housing, plastic screen
- Arm relieved by friction
- With switch in the luminaire head
- System of protection IP54; class of protection I
- Supplied with 1.5 m mains lead with plug type CEE 7/7 (shock-proof plug)
- Various fastenings as accessories

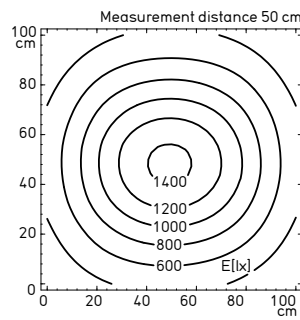

Illuminance 2 x 11 W

Integrated machine luminaires



Surface-mounted luminaires



Tube luminaires



Arm-mounted luminaires

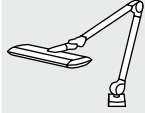

FITTED WITH	OPERATING DEVICE	CONNECTED LOAD	SPECIAL FEATURE	E_m / E_{max}^*	MODEL	ORDER NO.
2 x 11 WTC-L	Integrated transformer	230 V, 50 Hz	–	673/1424 lx ¹	WD 211	101 221 000 - 000 121 82

* E_m = medium illuminance; E_{max} = maximum illuminance; ¹ Measuring range 100 cm x 100 cm/Measuring distance 50 cm

TANEO

NEW

VARIABLE AND CONVENIENT.



•••••
LED





An uncompromising lighting solution is essential wherever your eyes are put to the test. Whether in manufacture, assembly, quality assurance or analysis, whether in labs, or the electronic, metal or watch industries – Taneo is a truly universal talent.

With luminous power to suit the particular application, high lighting quality and ergonomic handling, it provides optimum working conditions and is incomparable when it comes to adjusting to individual and task-related requirements.

- Maintenance-free LED technology with a service life of up to 50,000 hours and more
- Requirements-oriented output levels for up to 4,000 lx
- 30 % energy savings
- Continuously dimmable down to 10 %, with memory function
- Light Forming and Ray Mixing Technology for area light that is free from shadows and reflective glare
- Glare-free thanks to conical prismatic screen (CDP) or white opal screen
- Flicker-free light with no IR or UV content
- Good contrast sensitivity and very good color recognition thanks to premium LEDs
- Uniquely flexible and balanced arm with enormous operating radius
- Closed construction for protection of the user and the integrated technology
- Robust aluminum and fiberglass-reinforced high-performance plastic
- Premium workmanship in accordance with Waldmann's quality standards
- Also available in ESD design

Integrated
machine
luminaires



Surface-
mounted
luminaires



Tube
luminaires



Arm-mounted
luminaires

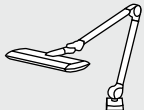

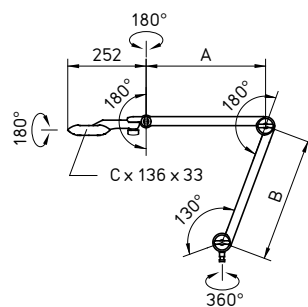

TANEO in ESD design

Dimension C: 15 W = 218 mm, 31 W = 398 mm,
47 W = 577 mm

CONSUMPTION	OPERATING DEVICE	CONNECTED LOAD	SPECIAL FEATURE	E_m/E_{max}^*	MODEL	ORDER NUMBER
15 W	Mains plug	100 – 240 V, 50/60 Hz	A = 384 mm, B = 400 mm CDP screen, 4,000 K	563/1569 lx ¹	STZL 12 R	112 576 000 - 005 441 67
15 W	Mains plug	100 – 240 V, 50/60 Hz	A = 384 mm, B = 400 mm CDP screen, 5,000 K	563/1569 lx ¹	STZL 12 R	112 576 000 - 005 397 57
15 W	Mains plug	100 – 240 V, 50/60 Hz	A = 384 mm, B = 400 mm White opal screen, 4,000 K	361/816 lx ¹	STZL 12 R	112 576 000 - 005 595 52
15 W	Mains plug	100 – 240 V, 50/60 Hz	A = 384 mm, B = 400 mm White opal screen, 5,000 K	361/816 lx ¹	STZL 12 R	112 576 000 - 005 595 71
31 W	Table power supply	100 – 240 V, 50/60 Hz	A = 384 mm, B = 400 mm CDP screen, 4,000 K	1137/3053 lx ¹	STZL 24 R	112 577 000 - 005 441 79
31 W	Table power supply	100 – 240 V, 50/60 Hz	A = 384 mm, B = 400 mm CDP screen, 5,000 K	1137/3053 lx ¹	STZL 24 R	112 577 000 - 005 397 74
31 W	Table power supply	100 – 240 V, 50/60 Hz	A = 384 mm, B = 400 mm White opal screen, 4,000 K	725/1578 lx ¹	STZL 24 R	112 577 000 - 005 595 74
31 W	Table power supply	100 – 240 V, 50/60 Hz	A = 384 mm, B = 400 mm White opal screen, 5,000 K	725/1578 lx ¹	STZL 24 R	112 577 000 - 005 595 77
31 W	Table power supply	100 – 240 V, 50/60 Hz	A = 244 mm, B = 450 mm White opal screen, 5,000 K	725/1578 lx ¹	STZL 24 R	113 085 000 - 005 832 20
47 W	Table power supply	100 – 240 V, 50/60 Hz	A = 384 mm, B = 400 mm CDP screen, 4,000 K	1641/4046 lx ¹	STZL 36 R	112 578 000 - 005 441 82
47 W	Table power supply	100 – 240 V, 50/60 Hz	A = 384 mm, B = 400 mm CDP screen, 5,000 K	1641/4046 lx ¹	STZL 36 R	112 578 000 - 005 397 77
47 W	Table power supply	100 – 240 V, 50/60 Hz	A = 384 mm, B = 400 mm White opal screen, 4,000 K	1082/2219 lx ¹	STZL 36 R	112 578 000 - 005 595 80
47 W	Table power supply	100 – 240 V, 50/60 Hz	A = 384 mm, B = 400 mm White opal screen, 5,000 K	1082/2219 lx ¹	STZL 36 R	112 578 000 - 005 595 83

ESD DESIGN

CONSUMPTION	OPERATING DEVICE	CONNECTED LOAD	SPECIAL FEATURE	E_m/E_{max}^*	MODEL	ORDER NUMBER
31 W	Table power supply	100 – 240 V, 50/60 Hz	A = 384 mm, B = 400 mm CDP screen, 4,000 K	1016/2671 lx ¹	STZL 24 AR	113 020 000 - 005 645 43
31 W	Table power supply	100 – 240 V, 50/60 Hz	A = 384 mm, B = 400 mm CDP screen, 5,000 K	1016/2671 lx ¹	STZL 24 AR	113 020 000 - 005 645 62

* E_m = Medium illuminance; E_{max} = Maximum illuminance; ¹ Measuring range 100 cm x 100 cm / Measuring distance 50 cm
Also available as a workplace-system luminaire



Features at a glance

- 12, 24 or 36 x LED
- Color temperature neutral white 4,000 K or 5,000 K
- Glare-free thanks to conical prismatic screen (CDP) or white opal screen
- Housing made of colorless anodized or black-painted aluminum and black plastic, screen made of PMMA (CDP) or PC (white opal screen)
- Spring-balanced arm with 3D head joint
- Touch panel integrated in the luminaire head for On/Off and dimming
- System of protection IP20; class of protection II
- Supplied with 3 m mains lead with mains plug (15 W) or table power supply (31 and 47 W) with plug type 7/16 (Euro plug)
- Various fastenings and add-on magnifier (3.5 diopters) as accessories

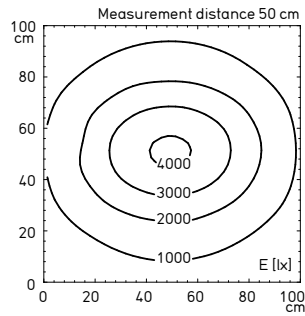

Illuminance based on the example of 47 W with CDP screen

Integrated machine luminaires



Surface-mounted luminaires



Tube luminaires



Arm-mounted luminaires

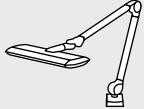

STE 111

ULTRA ERGONOMIC.



In many companies, luminaires are practically in use around the clock. In addition to standard-compliant brightness, energy efficiency and long life are the decisive criteria for finding the right solution. Waldmann calls this STE 111: Thanks to modern fluorescent lamp technology, the

STE 111 provides an incredible luminous intensity with a low energy consumption. Thanks to various fittings and glare-free options, it is also suitable for universal use.

- Energy-efficient and very bright
- Glare-free for even area lighting of desks
- Robust, durable metal construction
- Easy to adjust to your individual position
- With switch integrated in the luminaire

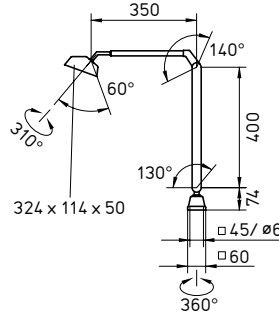

Integrated machine luminaires



Surface-mounted luminaires



Tube luminaires



Arm-mounted luminaires



Features at a glance

- TC-SEL compact fluorescent lamp
- Color temperature neutral white 4,000 K
- Glare-free thanks to white opal screen
- Light gray plastic housing, plastic screen
- Balanced by friction
- With switch in the luminaire head
- System of protection IP20; class of protection I
- Supplied with 1.5 m mains lead with plug type CEE 7/7 (shock-proof plug)
- Various fastenings and magnifiers (4 diopters) as an accessory

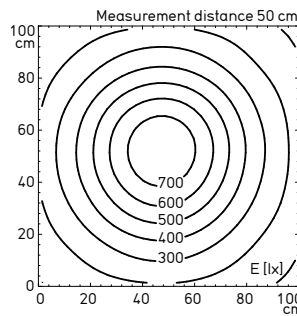

Illuminance 1 x 11 W

FITTED WITH	OPERATING DEVICE	CONNECTED LOAD	SPECIAL FEATURE	E_m/E_{max}^*	MODEL	ORDER NO.
1 x 11 WTC-SEL	Integr. electronic ballast	220 – 240 V, 50 Hz	Screen	355/782 lx ¹	STE 111	112 349 000 - 000 393 95

* E_m = medium illuminance; E_{max} = maximum illuminance; ¹ Measuring range 100 cm x 100 cm/Measuring distance 50 cm, Also available as a flexible-tube luminaire

SN/SNE

INTELLIGENT LIGHTING COMFORT.

Efficiency is nothing more than a buzzword, but today it plays a key role in industry and trade. The SN/SNE enables you to easily attain this. It not only offers state-of-the-art energy-saving technology, but also a high level of efficiency.

Its cleverly designed arm also ensures a radius of action that easily gives you light where you need it.

- Energy-efficient and very bright
- Ergonomically shaped T-screws for arm-adjustment without tools

- Light and easy to adjust to your individual position
- Glare-free
- Robust, durable construction
- Luminaire head that remains cool



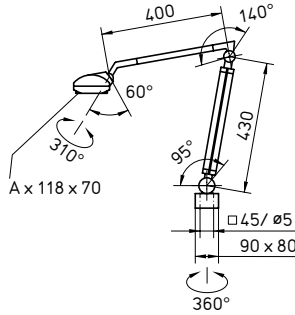

Dimension A: 18 W = 308 mm
36 W = 485 mm

Features at a glance

- TC-L compact fluorescent lamp
- Color temperature neutral white 4,000 K
- Glare-free thanks to aluminized parabolic louver or white opal screen
- Light gray plastic housing, plastic screen or louver
- Spring-balanced arm
- With switch in the luminaire head (conventional ballast) or in the arm (electronic ballast)
- System of protection IP20; class of protection I
- Supplied with 1.5 m mains lead with plug type CEE 7/7 (shock-proof plug)
- Various fastenings and magnifier (3 diopters) as accessories

Integrated machine luminaires



Surface-mounted luminaires



Tube luminaires



Arm-mounted luminaires

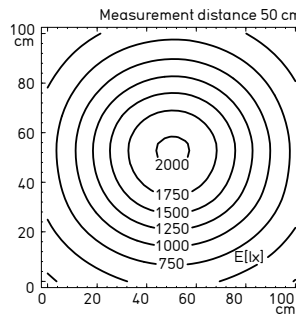
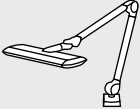

Illuminance based on the example 1 x 36 W with parabolic louver

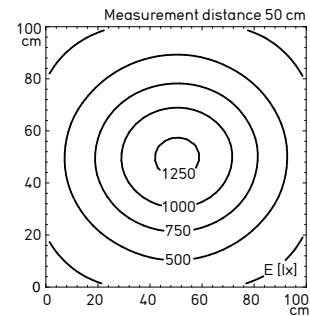

Illuminance based on the example 1 x 36 W with screen























FITTED WITH	OPERATING DEVICE	CONNECTED LOAD	SPECIAL FEATURE	E_m / E_{max}^*	MODEL	ORDER NO.
1 x 18 WTC-L	Conventional ballast integr.	230 V, 50 Hz	Parabolic louver	415/946 lx ¹	SN 118	111 001 000 - 000 500 14
1 x 18 WTC-L	Conventional ballast integr.	230 V, 50 Hz	Screen	262/585 lx ¹	SN 118	111 001 002 - 000 955 11
1 x 18 WTC-L	Integr. electronic ballast	220 – 240 V, 50/60 Hz	Parabolic louver	415/946 lx ¹	SNE 118	111 581 000 - 000 589 89
1 x 18 WTC-L	Integr. electronic ballast	220 – 240 V, 50/60 Hz	Screen	281/633 lx ¹	SNE 118	111 581 002 - 000 955 97
1 x 36 WTC-L	Conventional ballast integr.	230 V, 50 Hz	Parabolic louver	933/2010 lx ¹	SN 136	111 011 000 - 000 495 95
1 x 36 WTC-L	Conventional ballast integr.	230 V, 50 Hz	Screen	597/1268 lx ¹	SN 136	111 011 002 - 000 955 96
1 x 36 WTC-L	Integr. electronic ballast	220 – 240 V, 50/60 Hz	Parabolic louver	933/2010 lx ¹	SNE 136	111 591 000 - 000 718 46
1 x 36 WTC-L	Integr. electronic ballast	220 – 240 V, 50/60 Hz	Screen	597/1268 lx ¹	SNE 136	111 591 002 - 000 955 95

* E_m = medium illuminance; E_{max} = maximum illuminance; ¹ Measuring range 100 cm x 100 cm/Measuring distance 50 cm

FLEXIBLE-TUBE LUMINAIRES

Flexible-tube luminaires offer the highest lighting flexibility. The lighting can be quickly and easily adjusted to a wide range of activities at an industrial workplace or at a machine.



ABL		  IP67 or IP20	88 - 89	
SPOT LED			  IP65 or IP40	90 - 91
HSW 20		  IP65	92 - 93	
HI 20		   IP20	94 - 95	
SOL		  IP20	96 - 97	
MINELA			  IP20	98 - 99
STE 111		  IP20	100 - 101	

Integrated machine luminaires



Surface-mounted luminaires



Tube luminaires



Arm-mounted luminaires



Flexible-tube luminaires



ABL

THE FLEXIBLE HEAD FOR TOUGH TASKS.



With its minimalist design, the ABL is as small and handy as a mini flashlight that can be fixed in any position. The fact that it is extremely tough in spite of its delicate appearance makes it a highly versatile luminaire.

- Fast and precise positioning
- High luminous power with low energy consumption
- Variants with narrow and wide angles of illumination

- Insensitive to vibrations, resistant to metal chippings
- Maintenance-free: LED life of up to 50,000 hours and more



efficient *light*

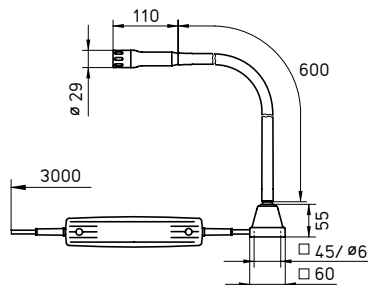

Tip: Drawing shows luminaire with separate transformer

Features at a glance

- 1 x HIGH POWER LED
- Color temperature daylight white 6,000 K
- 6° or 25° angle of illumination
- Black aluminum anodized housing, 2 mm thick safety glass
- Metal flexible tube for at least 20,000 movements
- Without switch
- System of protection IP67 (without transformer) or IP20 (with transformer, luminaire head IP67); class of protection III (without transformer) or II (with transformer)
- Supplied with 3 m mains lead with free stranded wires or integrated power pack with plug type CEE 7/16 (Euro plug)
- Various fastenings and drivers as accessories

Integrated machine luminaires

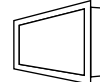

Surface-mounted luminaires

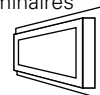

Tube luminaires



Arm-mounted luminaires



Flexible-tube luminaires

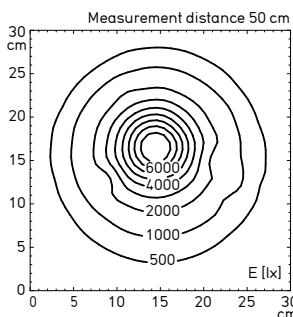

Illuminance with 6° lens

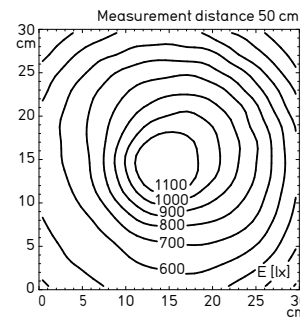

Illuminance with 25° lens

CONNECTION TO A CONSTANT POWER SOURCE WITH 350 OR 700 MA

CONSUMPTION	OPERATING DEVICE	CONNECTED LOAD	SPECIAL FEATURE	E_m/E_{max}^*	MODEL	ORDER NO.
3 W	-	Dependent on the driver	6° lens	1219/8966 lx ¹	ABLTL 1	112 423 000 - 000 715 50
3 W	-	Dependent on the driver	25° lens	691/1260 lx ¹	ABLTL 1	112 423 001 - 000 715 49

CONNECTION TO A CONSTANT POWER SOURCE WITH 350 OR 700 MA

CONSUMPTION	OPERATING DEVICE	CONNECTED LOAD	SPECIAL FEATURE	E_m/E_{max}^*	MODEL	ORDER NO.
3 W	Transformer in separate housing	95 – 240 V, 50/60 Hz	6° lens	1219/8966 lx ¹	ABLTL 1	112 426 000 - 000 740 02
3 W	Transformer in separate housing	95 – 240 V, 50/60 Hz	25° lens	691/1260 lx ¹	ABLTL 1	112 426 001 - 000 741 55

* E_m = medium illuminance; E_{max} = maximum illuminance; ¹ Measuring range 30 cm x 30 cm/Measuring distance 50 cm
Also available as a pivoting-head luminaire

SPOT LED



HARD CORE, FLEXIBLE ADJUSTMENT.



A luminaire that is used close to the workplace should be both compact, powerful and robust. This is why the SPOT LED combines 3 LEDs in its extremely small, insensitive housing. They produce flicker-free light that can be precisely positioned even in small spaces thanks to the flexible tube.

- Very bright and energy-efficient
- Variants with narrow and wide angles of illumination
- Wide range
- Comfort and safety thanks to absolutely even and flicker-free light
- Without heat development in the beam direction
- Convenient switching on and off from your working position
- Maintenance-free: LED life of up to 50,000 hours and more

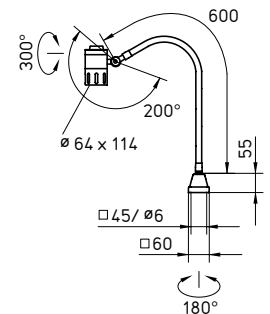

Features at a glance

- 3 x HIGH POWER LED
- Color temperature daylight white 5,700 K
- 10° or 40° angle of illumination
- Black aluminum anodized housing, 3 mm thick safety glass
- Metal flexible tube for at least 20,000 movements
- With switch in the luminaire head
- System of protection IP65 (without mains plug) or IP40 (with mains plug, luminaire head IP65); class of protection III (without mains plug) or II (with mains plug)
- Supplied with 3 m mains lead with free stranded wires or with mains plug type CEE 7/16 (Euro plug), BS 1363 and NEMA 1-15P
- Various fastenings as accessories

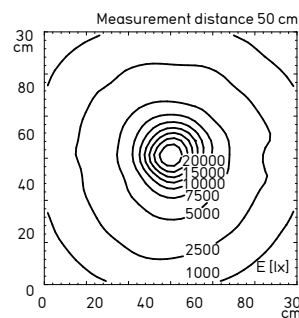

Illuminance with 10° lens

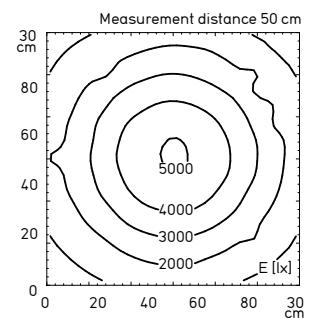

Illuminance with 40° lens



Integrated machine luminaires



Surface-mounted luminaires



Tube luminaires



Arm-mounted luminaires

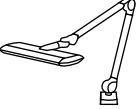

Flexible-tube luminaires

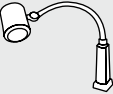

CONSUMPTION	OPERATING DEVICE	CONNECTED LOAD	SPECIAL FEATURE	E_m/E_{max}^*	MODEL	ORDER NO.
7 W	Mains plug	100 – 240 V, 50/60 Hz	10° lens	3358/22350 lx ¹	MCTFL 3 N	112 462 007 - 000 919 26
7 W	Mains plug	100 – 240 V, 50/60 Hz	40° lens	2539/5095 lx ¹	MCTFL 3 N	112 462 009 - 000 919 70
6 W	–	16 – 30 VAC/16 – 40 VDC	10° lens	3358/22350 lx ¹	MCTFL 3 S	112 462 001 - 000 918 51
6 W	–	16 – 30 VAC/16 – 40 VDC	40° lens	2539/5095 lx ¹	MCTFL 3 S	112 462 003 - 000 919 60

* E_m = medium illuminance; E_{max} = maximum illuminance; ¹ Measuring range 30 cm x 30 cm/Measuring distance 50 cm

Also available as an arm-mounted luminaire, pivoting-head luminaire, integrated machine luminaire and surface-mounted luminaire

HSW 20

SIMPLY BRILLIANT.

Occupational safety conditions dictate that light at the workplace must be glare-free. In spite of its very strong halogen light, the HSW 20 reliably fulfills these requirements. Thanks to the maneuverability offered by its flexible tube, it provides excellent focused light in a direct, pleasant and fast manner.

- Brilliant halogen light
- Variants with narrow and wide angles of illumination
- Glare-free
- Easy changing of illuminant
- Easy to reach switch that can be operated with one hand
- Twin glass screen
- No burning in of cooling agents thanks to reduced temperatures on the surface of the luminaire
- High system of protection



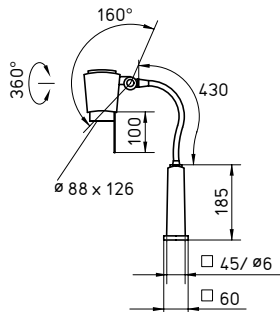

Features at a glance

- Halogen lamp
- Color temperature warm white 2,800 K (23 W) or 3,100 K (20 W)
- Glare-free thanks to metal louver, angle of illumination 10° or 36°
- Luminaire head of special black plastic, twin glass screen
- Metal flexible tube for at least 20,000 movements
- With switch in the luminaire head
- System of protection IP65; class of protection I (without transformer) or II (with transformer)
- Supplied with 1.5 m mains lead with free stranded wires or plug type CEE 7/17 (shaped plug) for mains variant
- Various fastenings and magnifier (5 diopters) as accessories

Integrated machine luminaires

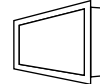

Surface-mounted luminaires

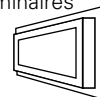

Tube luminaires



Arm-mounted luminaires



Flexible-tube luminaires

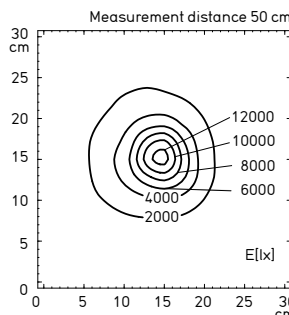
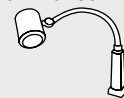

Illuminance with 10° angle of illumination (112 048 000 - 000 788 81)

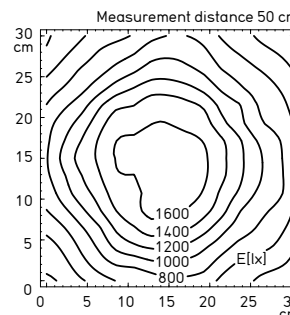

Illuminance with 36° angle of illumination (112 048 038 - 000 788 82)

FITTED WITH	OPERATING DEVICE	CONNECTED LOAD	SPECIAL FEATURE	E _m /E _{max} *	MODEL	ORDER NO.
1 x 20 W	Integrated transformer	230 V, 50/60 Hz	10° angle of illumination	1295/12740 lx ¹	HSWT 20	112 048 000 - 000 788 81
1 x 20 W	Integrated transformer	230 V, 50/60 Hz	36° angle of illumination	959/1698 lx ¹	HSWT 20	112 048 038 - 000 788 82
1 x 23 W	–	24 VAC/DC	10° angle of illumination	1295/12740 lx ¹	HSWT 20	112 049 010 - 000 788 85
1 x 20 W	–	12 VAC/DC	10° angle of illumination	1295/12740 lx ¹	HSWT 20	112 049 000 - 000 788 83
1 x 20 W	–	12 VAC/DC	36° angle of illumination	959/1698 lx ¹	HSWT 20	112 049 012 - 000 788 84

* E_m = medium illuminance; E_{max} = maximum illuminance; ¹ Measuring range 30 cm x 30 cm/Measuring distance 50 cm
 Also available as an arm-mounted and pivoting-head luminaire

HI 20

THE VARIABLE LIGHTING SOLUTION.



When it comes to the HI 20, diversity not only means that it is available with various angles of illumination. In conjunction with the flexible tube, it can easily be brought into the right position in tight spaces. Its extra strong halogen lamp can thus light up every angle.

- Versatile halogen luminaire
- Brilliant halogen light
- Variants with narrow and wide angles of illumination
- Easy and fast positioning
- Bright
- Heat protection jacket
- Easy, tool-free changing of lamp
- Convenient switching on and off from your working position
- High life cycle of the lamp



Features at a glance

- Halogen lamp
- Color temperature warm white 2,800 K (23 W) or 3,000 K (20 W)
- 10°, 24°, 36° or 60° angle of illumination
- Black luminaire head of aluminum and plastic, glass screen
- Metal flexible tube for at least 20,000 movements
- With switch in the luminaire head
- System of protection IP20; class of protection III (without transformer) or II (with transformer)
- Supplied with 1.5 m mains lead with free stranded wires or plug type CEE 7/16 (Euro plug) for mains variant
- Various fastenings and magnifier (4 diopters) as accessories



HI 20 with integrated transformer

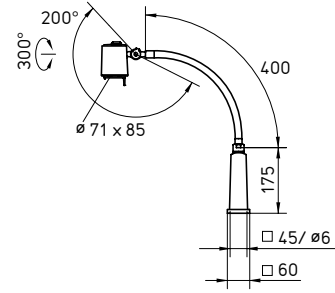

HI 20 without transformer

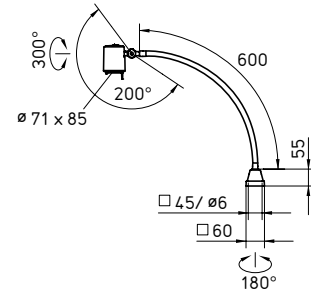

Integrated machine luminaires



Surface-mounted luminaires



Tube luminaires



Arm-mounted luminaires

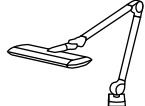

Flexible-tube luminaires

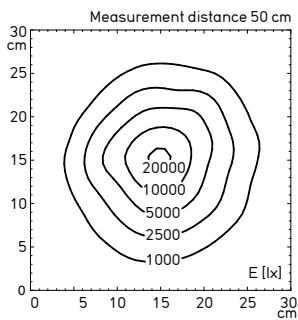
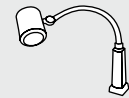

Illuminance with 10° angle of illumination (112 378 000 - 000 608 54)

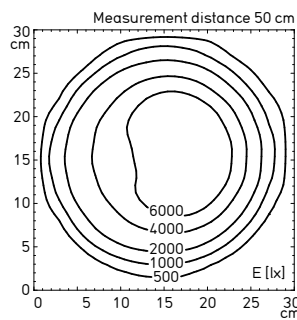

Illuminance with 24° angle of illumination (112 378 001 - 000 683 32)

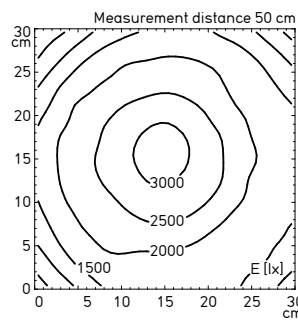

Illuminance with 36° angle of illumination (112 378 002 - 000 683 34)

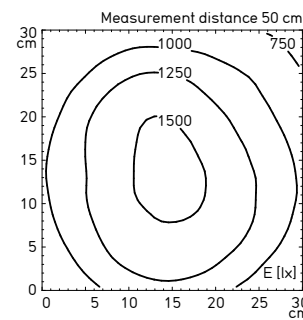

Illuminance with 60° angle of illumination (112 378 003 - 000 683 39)

FITTED WITH	OPERATING DEVICE	CONNECTED LOAD	SPECIAL FEATURE	E_m/E_{max}^*	MODEL	ORDER NO.
1 x 20 W	Integrated transformer	230 V, 50/60 Hz	10° angle of illumination	2268/23200 lx ¹	HITH 20 N	112 378 000 - 000 608 54
1 x 20 W	Integrated transformer	230 V, 50/60 Hz	24° angle of illumination	2504/7375 lx ¹	HITH 20 N	112 378 001 - 000 683 32
1 x 20 W	Integrated transformer	230 V, 50/60 Hz	36° angle of illumination	1970/3126 lx ¹	HITH 20 N	112 378 002 - 000 683 34
1 x 20 W	Integrated transformer	230 V, 50/60 Hz	60° angle of illumination	1182/1598 lx ¹	HITH 20 N	112 378 003 - 000 683 39
1 x 20 W	–	12 VAC/DC	24° angle of illumination	2504/7375 lx ¹	HITF 20 S	112 379 025 - 000 684 01
1 x 23 W	–	24 VAC/DC	10° angle of illumination	1619/14398 lx ¹	HITF 20 S	112 379 028 - 000 609 06
1 x 23 W	–	24 VAC/DC	24° angle of illumination	1683/7082 lx ¹	HITF 20 S	112 379 029 - 000 903 37
1 x 23 W	–	24 VAC/DC	36° angle of illumination	1553/3055 lx ¹	HITF 20 S	112 379 030 - 000 903 39

* E_m = medium illuminance; E_{max} = maximum illuminance; ¹ Measuring range 30 cm x 30 cm/Measuring distance 50 cm

Also available as an arm-mounted and pivoting-head luminaire

SOL

IMPRESSIVE MINIMALISM.

Sometimes, a universal solution is simply the best solution. Particularly when it combines the properties of the SOL. It evenly illuminates the work space with neutral white light and is also very energy-efficient.

And thanks to the flexible tube it can be individually positioned.

- Light and easy to adjust to your individual position
- Compact and bright
- Switch integrated in the luminaire head



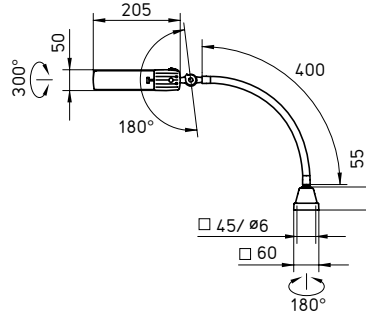

Features at a glance

- TC-S compact fluorescent lamp
- Color temperature neutral white 4,000 K
- Glare-free thanks to in-built reflector
- Black plastic housing
- Metal flexible tube for at least 20,000 movements
- With switch in the luminaire head
- System of protection IP20; class of protection II
- Supplied with 2 m mains lead with plug type CEE 7/16 (Euro plug)
- Various fastenings as accessories

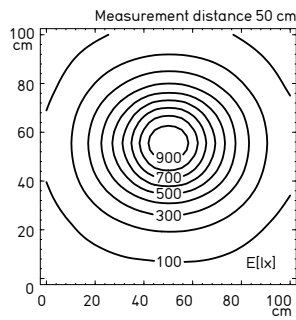

Illuminance 1 x 9 W

Integrated machine luminaires



Surface-mounted luminaires



Tube luminaires



Arm-mounted luminaires

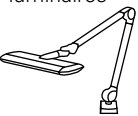

Flexible-tube luminaires

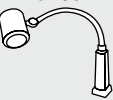

FITTED WITH	OPERATING DEVICE	CONNECTED LOAD	SPECIAL FEATURE	E_m / E_{max}^*	MODEL	ORDER NO.
1 x 9 W TC-S	Conventional plug-in ballast	230 V, 50 Hz	–	233/953 lx ¹	SOL 109	112 390 000 - 000 715 41

* E_m = medium illuminance; E_{max} = maximum illuminance; ¹ Measuring range 100 cm x 100 cm / Measuring distance 50 cm

MINELA

NEW

FLEXIBLE AND EFFICIENT LIGHTING.



This luminaire thinks for itself, switching off automatically after 14 hours and therefore preventing unnecessary power consumption. The LED luminaire also features cleverly designed thermal management, which ensures high energy efficiency,

longer service life and less heating up of the luminaire head.

- Light and easy to adjust to your individual position
- Switch-off and dimming with a light touch of the touch-LED

- Intelligent Auto-Off function reduces power consumption

- Maintenance-free LED technology with a service life of up to 50,000 hours and more



efficient *light*

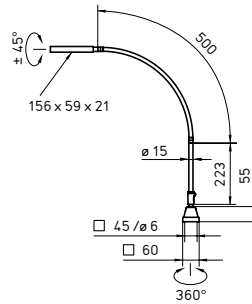

Features at a glance

- 1 x HIGH POWER LED
- Color temperature neutral white 4,000 K
- Light control via reflector
- Colorless anodized aluminum housing, acrylic screen
- Metal flexible tube for at least 20,000 movements
- Illuminated touch-LED integrated in the luminaire head for On/Off and dimming
- System of protection IP20; class of protection II
- Supplied with 2.5 m mains lead and with mains plug type CEE 7/16 (Euro plug), BS 1363 and NEMA 1-15P
- Various fastenings as accessories

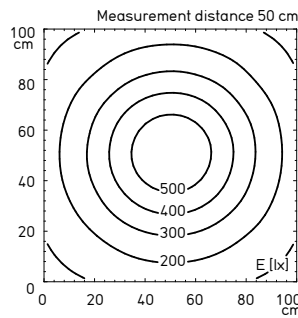

Illuminance 1 x 7 W

Integrated machine luminaires



Surface-mounted luminaires



Tube luminaires



Arm-mounted luminaires

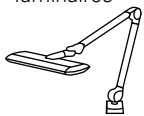

Flexible-tube luminaires

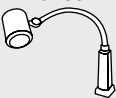

CONSUMPTION	OPERATING DEVICE	CONNECTED LOAD	SPECIAL FEATURE	E_m/E_{max}^*	MODEL	ORDER NUMBER
7 W	Mains plug	100 – 240 V, 50/60 Hz	Dimmable	268/575 lx ¹	SOL 1	112 929 000 - 005 953 21

* E_m = Medium illuminance; E_{max} = Maximum illuminance; ¹ Measuring range 100 cm x 100 cm/Measuring distance 50 cm

STE 111

GOOD LIGHT IS A MATTER OF ADJUSTMENT.

When a luminaire is in use almost all day and all night in industrial assembly or inspection, it is important for it to provide comfortable lighting. But it also needs to consume as little energy as possible. Thanks to state-of-the-art fluorescent lamp technology, the STE 111 can do both.

This makes it a universal flexible tube luminaire, which thanks to its features is also highly suitable for illuminating small parts.

- Even area lighting
- Energy-efficient and very bright
- Glare-free
- Light and easy to adjust to your individual position
- Switch integrated in the luminaire head



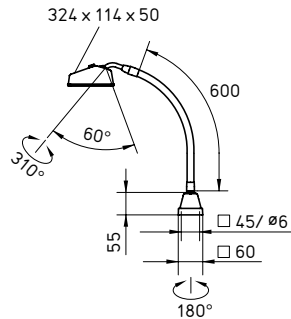

Features at a glance

- TC-SEL compact fluorescent lamp
- Color temperature neutral white 4,000 K
- Glare-free thanks to white opal screen
- Light gray plastic housing, acrylic screen
- Metal flexible tube for at least 20,000 movements
- With switch in the luminaire head
- System of protection IP 20, class of protection I
- Supplied with 3 m mains lead with plug type CEE 7/7 (shock-proof plug)
- Various fastenings and magnifier (4 diopters) as accessories

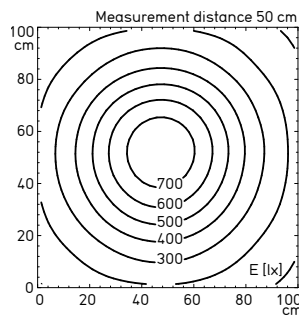

Illuminance 1 x 11 W

Integrated machine luminaires



Surface-mounted luminaires



Tube luminaires



Arm-mounted luminaires

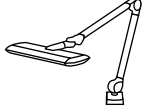

Flexible-tube luminaires

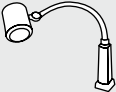



























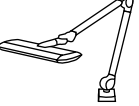

FITTED WITH	OPERATING DEVICE	CONNECTED LOAD	SPECIAL FEATURE	E_m / E_{max}^*	MODEL	ORDER NO.
1 x 11 WTC-SEL	Integr. electronic ballast	220 – 240 V, 50 Hz	–	355/782 lx ¹	STE 111	112 399 000 - 000 729 37

* E_m = medium illuminance; E_{max} = maximum illuminance; ¹ Measuring range 100 cm x 100 cm/Measuring distance 50 cm
 Also available as an arm-mounted luminaire

PIVOTING-HEAD LUMINAIRES

Pivoting-head luminaires are mainly suitable for error-free and safe adjustment and maintenance work. The direct and focused light can be individually positioned within the processing area.



ABL		  IP67	104 - 105	Integrated machine luminaires 
SPOT LED	 	  IP67	106 - 107	Surface-mounted luminaires 
HSW 20		  IP65	108 - 109	Tube luminaires 
HSW 75		  IP65	110 - 111	Arm-mounted luminaires 
MHW		  IP65	112 - 113	Flexible-tube luminaires 
HI 20		   IP20	114 - 115	Pivoting-head luminaires 
HGL		  IP20	116 - 117	

ABL

EVERYTHING ON THE INSIDE. EVERYTHING ON THE OUTSIDE.



Even though it sounds contradictory: The ABL is so small because it performs a big and important task. With its compact dimensions and the integrated ball joint, it brings light to places where it seems almost impossible, but where it is urgently needed .

- High luminous power
- Fast and precise positioning
- Variants with narrow and wide angles of illumination
- Minimal design
- Low energy consumption
- Insensitive to vibrations, resistant to metal chippings
- High system of protection
- Maintenance-free: LED life of up to 50,000 hours and more



efficient *light*

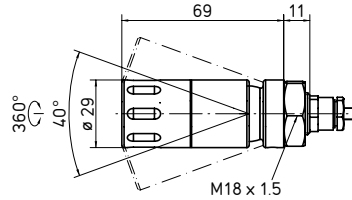

Features at a glance

- 1 x HIGH POWER LED
- Color temperature daylight white 6,000 K
- 6° or 25° angle of illumination
- Black anodized aluminum housing, 2 mm thick safety glass
- Ball joint for individual adjustments
- Without switch
- System of protection IP67; class of protection III
- Supplied with 1.5 m mains lead and free stranded wires
- Various operating devices as accessories

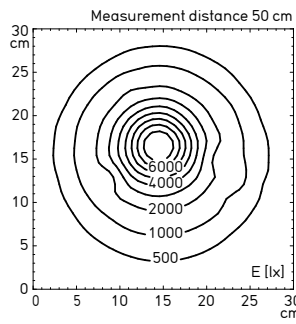

Illuminance with 6° lens

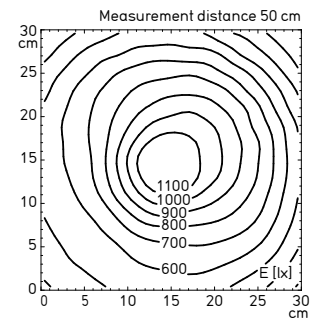

Illuminance with 25° lens

Integrated machine luminaires



Surface-mounted luminaires



Tube luminaires



Arm-mounted luminaires

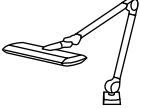

Flexible-tube luminaires

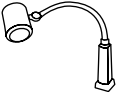

Pivoting-head luminaires



CONNECTION TO A CONSTANT POWER SOURCE WITH 350 OR 700 MA

CONSUMPTION	OPERATING DEVICE	CONNECTED LOAD	SPECIAL FEATURE	E_m/E_{max} *	MODEL	ORDER NO.
3 W	–	Dependent on the ballast	6° lens	1219/8966 lx ¹	ABLL 1	112 353 000 - 000 412 01
3 W	–	Dependent on the ballast	25° lens	691/1260 lx ¹	ABLL 1	112 353 001 - 000 419 41

* E_m = medium illuminance; E_{max} = maximum illuminance; ¹ Measuring range 30 cm x 30 cm/Measuring distance 50 cm
 Also available as a flexible-tube luminaire

SPOT LED



THE ULTRA POWERFUL LED LUMINAIRE.



Probably the easiest and most convenient way to install light in small machine tools is called SPOT LED. Its strong, but energy-saving LEDs provide spot or area lighting depending on the variant you choose: The fact that the luminaire can be easily and quickly attached to the machine wall thanks to the magnet that comes as an accessory means that you can rapidly generate light where you need it – thanks to its compact design, even close to the tool.

- Very bright with low energy consumption
- Variants with narrow and wide angles of illumination
- Easy, fast and flexible installation
- Absolutely even and flicker-free light for added safety
- Without heat development in the beam direction
- Adjustable beam direction
- Unlimited functionality irrespective of fluctuations of mains voltage
- High system of protection
- Maintenance-free: LED life of up to 50,000 hours and more



LED



efficient *light*

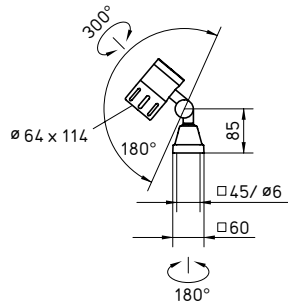

Features at a glance

- 3 x HIGH POWER LED
- Color temperature daylight white 5,700 K
- 10° or 40° angle of illumination
- Black anodized aluminum housing, 3 mm thick safety glass
- Head joint for individual adjustments
- Without switch
- System of protection IP67; class of protection III
- Supplied with 3 m mains lead and free stranded wires
- Various fastenings and operating devices for connecting to the mains voltage as accessories

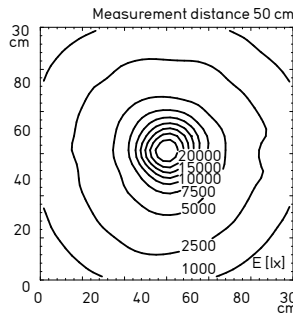

Illuminance with 10° lens

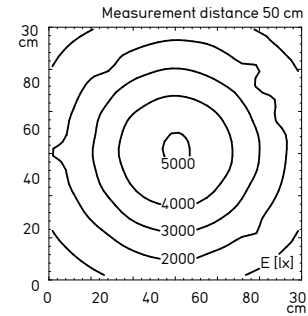

Illuminance with 40° lens

Integrated machine luminaires



Surface-mounted luminaires



Tube luminaires



Arm-mounted luminaires



Flexible-tube luminaires

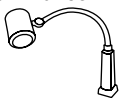

Pivoting-head luminaires



CONSUMPTION	OPERATING DEVICE	CONNECTED LOAD	SPECIAL FEATURE	E_m/E_{max}^*	MODEL	ORDER NO.
6 W	-	16 – 30 VAC/16 – 40 VDC	10° lens	3358/22350 lx ¹	MCXFL 3 S	112 459 004 - 000 829 50
6 W	-	16 – 30 VAC/16 – 40 VDC	40° lens	2539/5095 lx ¹	MCXFL 3 S	112 459 006 - 000 878 99

* E_m = medium illuminance; E_{max} = maximum illuminance; ¹ Measuring range 30 cm x 30 cm/Measuring distance 50 cm

Also available as an arm-mounted luminaire, flexible-tube luminaire, integrated machine luminaire and surface-mounted luminaire

HSW 20

SPOT LIGHTING: THIS IS WHAT EXCELLENT LIGHT LOOKS LIKE.



Irrespective of whether there is a narrow or a wide beam characteristic: If an excellent spot light is needed in the machine, the HSW 20 is the right choice. For a halogen luminaire it remains incredibly cool and easy to handle. No burning in of cooling agents.

- Brilliant halogen light
- Glare-free thanks to metal louver
- Variants with narrow and wide angles of illumination
- Easy changing of illuminant

- Low temperatures in the beam direction thanks to twin glass screen
- High system of protection

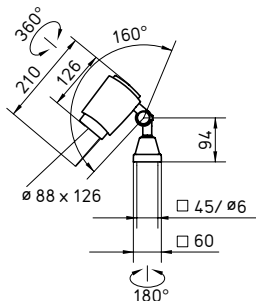

Features at a glance

- Halogen lamp
- Color temperature warm white 2,800 K (23 W) or 3,100 K (20 W)
- Glare-free thanks to metal louver, angle of illumination 10° or 36°
- Luminaire head of special black plastic, twin glass screen
- Head joint for individual adjustments
- Without switch
- System of protection IP65; class of protection I
- Supplied with 1.5 m mains lead and free stranded wires
- Various fastenings and transformers for connecting to the mains voltage as accessories

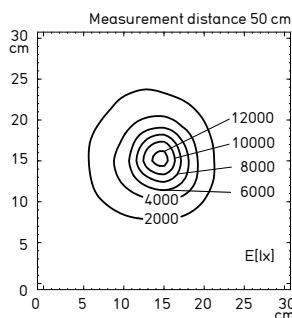

Illuminance with 10° angle of illumination (112 081 000 - 000 781 97)

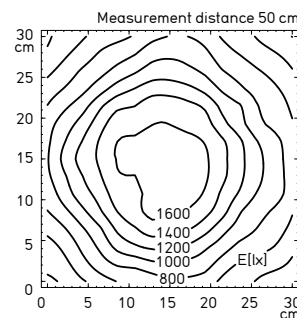

Illuminance with 36° angle of illumination (112 081 012 - 000 781 99)

Integrated machine luminaires

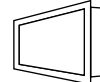

Surface-mounted luminaires

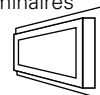

Tube luminaires



Arm-mounted luminaires



Flexible-tube luminaires



Pivoting-head luminaires



FITTED WITH	OPERATING DEVICE	CONNECTED LOAD	SPECIAL FEATURE	E_m/E_{max} *	MODEL	ORDER NO.
1 x 23 W	-	24 VAC/DC	10° angle of illumination	1568/14550 lx ¹	HSWK 20	112 081 010 - 000 781 98
1 x 20 W	-	12 VAC/DC	10° angle of illumination	1295/12740 lx ¹	HSWK 20	112 081 000 - 000 781 97
1 x 20 W	-	12 VAC/DC	36° angle of illumination	959/1698 lx ¹	HSWK 20	112 081 012 - 000 781 99

* E_m = medium illuminance; E_{max} = maximum illuminance; ¹ Measuring range 30 cm x 30 cm/Measuring distance 50 cm
 Also available as an arm-mounted and flexible-tube luminaire

HSW 75

A HEAD FULL OF IDEAS.

The HSW 75 is one of Waldman's strongest halogen luminaires. The fact that it is positioned on a jointed head enables space-saving attachment to the machine:

The resulting flexibility means that your light illuminates the processing area in a safe, glare-free and focused manner.

- Flexible, strong spot light
- Glare-free

- High system of protection
- Easy changing of illuminant thanks to bayonet connection
- Heat protection jacket



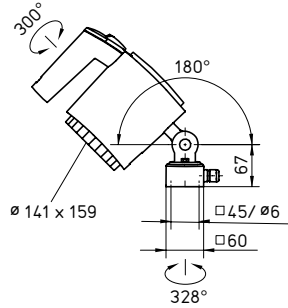

Features at a glance

- Halogen lamp
- Color temperature warm white 3,000 K
- Glare-free thanks to metal louver
- Black luminaire head of aluminum and plastic, glass screen
- Pivoting-head for individual adjustments
- Without switch
- System of protection IP65; class of protection II (with transformer) or III (without transformer)
- Supplied without mains lead
- Various fastenings as accessories

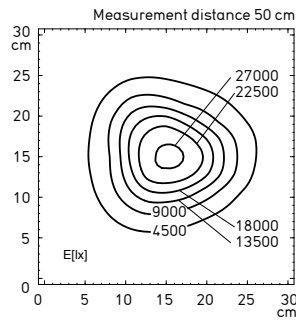

Illuminance 1 x 75 W
(112 188 003 - 000 051 86)

Integrated machine luminaires



Surface-mounted luminaires



Tube luminaires



Arm-mounted luminaires

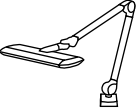

Flexible-tube luminaires

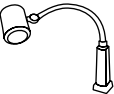

Pivoting-head luminaires



FITTED WITH	OPERATING DEVICE	CONNECTED LOAD	SPECIAL FEATURE	E_m/E_{max}^*	MODEL	ORDER NO.
1 x 75 W	Integrated transformer	230 V, 50/60 Hz	–	5052/27570 lx ¹	HSWK 75	112 188 003 - 000 051 86
1 x 75 W	–	24 VAC/DC	–	4964/26680 lx ¹	HSWK 75	112 187 013 - 000 052 36
1 x 75 W	–	12 VAC/DC	–	5062/27570 lx ¹	HSWK 75	112 187 003 - 000 051 85

* E_m = medium illuminance; E_{max} = maximum illuminance; ¹ Measuring range 30 cm x 30 cm/Measuring distance 50 cm
Also available as an arm-mounted luminaire

MHW

THE POWER OF HALOGEN.

All Waldmann luminaires are marked by their premium quality materials and robust construction. These qualities are particularly apparent in the MHW. Installed on a practical pivoting-head,

these characteristics guarantee a solid machine luminaire with flexible reliability and a long life.

- Bright
- Flexible
- High system of protection



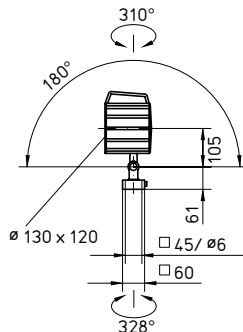

Features at a glance

- Halogen lamp
- Color temperature warm white 3,000 K
- Direct beam
- Aluminum colored anodized housing, glass screen
- Pivoting-head for individual adjustments
- Without switch
- System of protection IP65; class of protection III
- Supplied without mains lead
- Various fastenings and transformers to connect to the mains voltage as an accessory

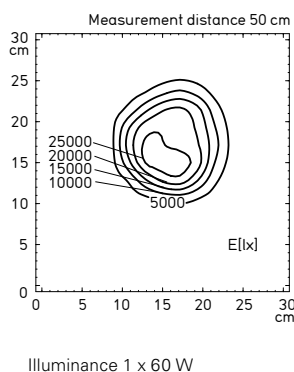

Integrated machine luminaires

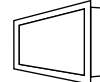

Surface-mounted luminaires

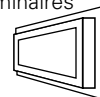

Tube luminaires



Arm-mounted luminaires



Flexible-tube luminaires



Pivoting-head luminaires



FITTED WITH	OPERATING DEVICE	CONNECTED LOAD	SPECIAL FEATURE	E_m / E_{max}^*	MODEL	ORDER NO.
1 x 60 W	-	24 VAC/DC	-	3341/27230 lx ¹	MHWK 60	110 960 000 - 000 037 22

* E_m = medium illuminance; E_{max} = maximum illuminance; ¹ Measuring range 30 cm x 30 cm / Measuring distance 50 cm
 Also available as an arm-mounted luminaire

HI 20

PRECISE MACHINE LIGHTING.

The HI 20 demonstrates the ideal kind of flexibility. As a fixture, its pivoting-head enables fully individual adjustment even in small machines. Furthermore, this strong halogen luminaire is available with four different beam characteristics. But the HI 20 has another variable that makes it even more flexible: The version with grip turns it into a practical hand luminaire.

- Very bright
- Easy and fast positioning
- Convenient switching on and off from your working position
- Variants with narrow and wide angles of illumination
- Easy, tool-free changing of lamp

Features at a glance

- Halogen lamp
- Color temperature warm white 2,800 K (23 W) or 3,000 K (20 W)
- 10°, 24°, 36° or 60° angle of illumination
- Black luminaire head of aluminum and plastic, glass screen
- Pivoting head for individual adjustments
- With switch in the luminaire head
- System of protection IP20; class of protection III (without transformer/mains plug) and II (with transformer/mains plug)
- Supplied with 2.5 m mains lead with free stranded wires or wall power supply/ integrated transformer with plug type CEE 7/16 (Euro plug)
- Various fastenings as accessories

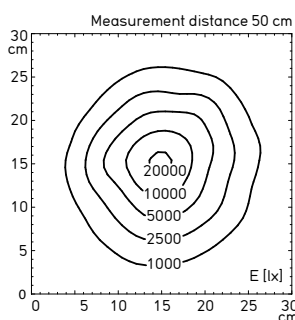

Illuminance with 10° angle of illumination (112 410 000 - 000 697 87)

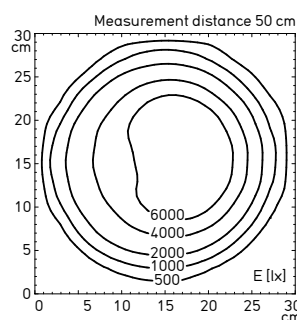

Illuminance with 24° angle of illumination (112 410 001 - 000 697 98)

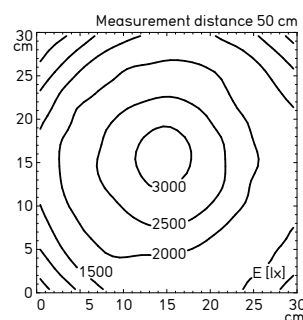

Illuminance with 36° angle of illumination (112 410 002 - 000 697 99)

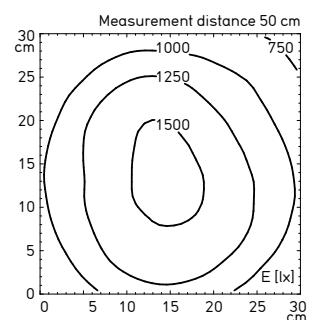

Illuminance with 60° angle of illumination (112 410 003 - 000 698 00)



HI 20

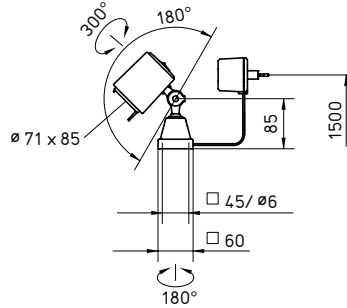

Tip: Drawing shows luminaire with mains plug



HI 20 with grip

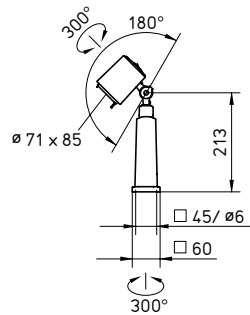

Integrated machine luminaires



Surface-mounted luminaires



Tube luminaires



Arm-mounted luminaires

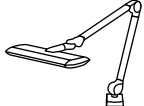

Flexible-tube luminaires

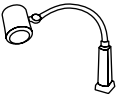

Pivoting-head luminaires



HI 20

FITTED WITH	OPERATING DEVICE	CONNECTED LOAD	SPECIAL FEATURE	E_m / E_{max}^*	MODEL	ORDER NO.
1 x 20 W	Mains plug	230 V, 50/60 Hz	10° angle of illumination	2268/23200 lx ¹	HIXF 20 N	112 410 000 - 000 697 87
1 x 20 W	Mains plug	230 V, 50/60 Hz	24° angle of illumination	2504/7375 lx ¹	HIXF 20 N	112 410 001 - 000 697 98
1 x 20 W	Mains plug	230 V, 50/60 Hz	36° angle of illumination	1970/3126 lx ¹	HIXF 20 N	112 410 002 - 000 697 99
1 x 20 W	Mains plug	230 V, 50/60 Hz	60° angle of illumination	1182/1598 lx ¹	HIXF 20 N	112 410 003 - 000 698 00
1 x 20 W	-	12 VAC/DC	24° angle of illumination	2504/7375 lx ¹	HIXF 20 S	112 381 005 - 000 684 37
1 x 23 W	-	24 VAC/DC	10° angle of illumination	1619/14398 lx ¹	HIXF 20 S	112 381 008 - 000 679 24
1 x 23 W	-	24 VAC/DC	24° angle of illumination	1683/7082 lx ¹	HIXF 20 S	112 381 009 - 000 903 40
1 x 23 W	-	24 VAC/DC	36° angle of illumination	1553/3055 lx ¹	HIXF 20 S	112 381 010 - 000 903 42

HI 20 WITH GRIP

FITTED WITH	OPERATING DEVICE	CONNECTED LOAD	SPECIAL FEATURE	E_m / E_{max}^*	MODEL	ORDER NO.
1 x 20 W	Integrated transformer	230 V, 50/60 Hz	10° angle of illumination	2268/23200 lx ¹	HIXH 20 N	112 391 000 - 000 673 44
1 x 20 W	Integrated transformer	230 V, 50/60 Hz	24° angle of illumination	2504/7375 lx ¹	HIXH 20 N	112 391 001 - 000 684 66
1 x 20 W	Integrated transformer	230 V, 50/60 Hz	36° angle of illumination	1970/3126 lx ¹	HIXH 20 N	112 391 002 - 000 684 72
1 x 20 W	Integrated transformer	230 V, 50/60 Hz	60° angle of illumination	1182/1598 lx ¹	HIXH 20 N	112 391 003 - 000 684 77
1 x 20 W	-	12 VAC/DC	24° angle of illumination	2504/7375 lx ¹	HIXH 20 S	112 382 005 - 000 684 40
1 x 23 W	-	24 VAC/DC	10° angle of illumination	1619/14398 lx ¹	HIXH 20 S	112 382 008 - 000 679 09
1 x 23 W	-	24 VAC/DC	24° angle of illumination	1683/7082 lx ¹	HIXH 20 S	112 382 009 - 000 903 56
1 x 23 W	-	24 VAC/DC	36° angle of illumination	1553/3055 lx ¹	HIXH 20 S	112 382 010 - 000 903 57

* E_m = medium illuminance; E_{max} = maximum illuminance; ¹ Measuring range 30 cm x 30 cm / Measuring distance 50 cm
 Also available as an arm-mounted and flexible-tube luminaire

HGL

BEST LIGHT – FOCUSED, GLARE-FREE LIGHTING.

The focused light that the HGL halogen luminaire produces is extremely bright. That is why a special metal louver ensures that this luminous power remains glare-free for an ergonomic lighting of the workplace. Mounted on a jointed head, this powerful luminaire remains flexible

enough for individual positioning of its extremely bright light. This makes the HGL a highly versatile luminaire.

- Extremely bright
- Glare-free
- Heat protection jacket



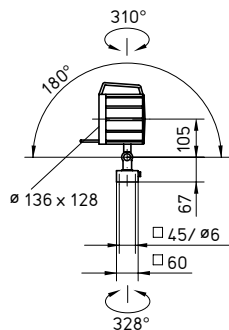

Features at a glance

- Halogen lamp
- Color temperature warm white 3,000 K
- Glare-free thanks to metal louver
- Black luminaire head of aluminum and plastic, glass screen
- Pivoting-head for individual adjustments
- With switch in the luminaire head
- System of protection IP20; class of protection III
- Supplied without mains lead
- Various fastenings and transformers to connect to the mains voltage as an accessory

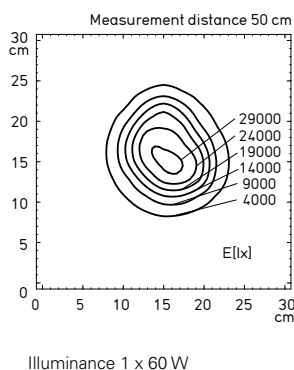

Integrated machine luminaires

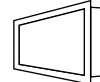

Surface-mounted luminaires

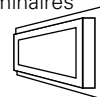

Tube luminaires



Arm-mounted luminaires



Flexible-tube luminaires



Pivoting-head luminaires













FITTED WITH	OPERATING DEVICE	CONNECTED LOAD	SPECIAL FEATURE	E_m / E_{max}^*	MODEL	ORDER NO.
1 x 60 W	–	24 VAC/DC	–	3243/29780 lx ¹	HGLK 70	010 308 000 - 000 478 88
1 x 55 W	–	12 VAC/DC	–	2933/25050 lx ¹	HGLK 70	010 308 010 - 000 646 57

* E_m = medium illuminance; E_{max} = maximum illuminance; ¹ Measuring range 30 cm x 30 cm/Measuring distance 50 cm
 Also available as an arm-mounted luminaire

MAGNIFIER LUMINAIRES

Magnifier luminaires are ideal for the precise inspection of parts in research, development and production. The combination of high-quality light and distortion-free magnification ensures premium inspection quality.

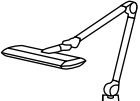
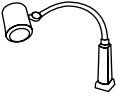
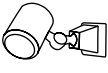
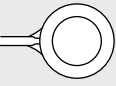

TEVISIO		  LED	IP20	120 - 123	Integrated machine luminaires 
RING LED		  LED	IP20	124 - 125	Surface-mounted luminaires 
SNL/SNLE		 	IP20	126 - 127	Tube luminaires 
RLL		 	IP20	128 - 129	Arm-mounted luminaires 
					Flexible-tube luminaires 
					Pivoting-head luminaires 
					Magnifier luminaires 

TEVISIO

THE EFFICIENT NO. 1 IN TERMS OF FLEXIBILITY AND QUALITY VISION.



Whether in labs, the electronic, metal or watch industries – TEVISIO is essential wherever your eyes are put to the test. In manufacture, assembly, quality assurance or analysis, it applies ergonomic perfection to support highly demanding visual tasks.

With highly developed LED technology, innovative arm technology and a field of vision that is ideally geared towards optic distance, the TEVISIO magnifier luminaire combines optimum efficiency and ergonomics at the workplace.

- 48 premium SMD LEDs
- 40 % energy savings
- Up to 6,000 lx at just 14 W
- Maintenance-free: LED life of up to 50,000 h and more
- Continuously dimmable down to 10 %
- Variants with Visualizer function for identifying structures and faults
- Color reproduction level 1A
- 3.5 diopters for approximately double magnification
- Absolutely scratch-proof glass magnifier, optionally nonreflecting
- Wide field of vision with Ø 153 mm for distortion-free vision
- Robust aluminum and high-performance plastic
- Closed joints protect the internal cables
- Enormous operating radius, uniquely flexible head joint
- Balanced arm, easily adjustable, can be precisely fixed if needed
- Also available in ESD design

LED





Integrated machine luminaires



Surface-mounted luminaires



Tube luminaires

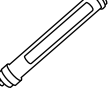

Arm-mounted luminaires

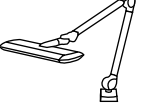

Flexible-tube luminaires

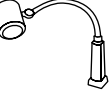

Pivoting-head luminaires



Magnifier luminaires

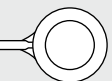



CONSUMPTION	OPERATING DEVICE	CONNECTED LOAD	SPECIAL FEATURE	E_m/E_{max}^*	MODEL	ORDER NUMBER	
14 W	Mains plug	100 – 240 V, 50/60 Hz	A = 484 mm, B = 500 mm	4002/6141 lx ¹	RLLQ 48 R	112 918 000 - 004 908 93	
NEW	14 W	Mains plug	100 – 240 V, 50/60 Hz	A = 484 mm, B = 500 mm Nonreflecting lens	4002/6141 lx ¹	RLLQ 48 R	112 918 000 - 005 472 74
14 W	Mains plug	100 – 240 V, 50/60 Hz	A = 484 mm, B = 500 mm Add-on lens 8 dpt	4002/6141 lx ¹	RLLQ 48 R	112 918 001 - 004 991 54	
14 W	Mains plug	100 – 240 V, 50/60 Hz	A = 484 mm, B = 500 mm Visualizer	4002/6141 lx ¹	RLLQ 48/2 R	112 918 002 - 005 090 20	
NEW	14 W	Mains plug	100 – 240 V, 50/60 Hz	A = 484 mm, B = 500 mm Nonreflecting lens, Visualizer	4002/6141 lx ¹	RLLQ 48/2 R	112 918 000 - 005 472 79
14 W	Mains plug	100 – 240 V, 50/60 Hz	A = 484 mm, B = 500 mm Add-on lens 8 dpt, Visualizer	4002/6141 lx ¹	RLLQ 48/2 R	112 918 003 - 005 090 17	
14 W	Mains plug	100 – 240 V, 50/60 Hz	A = 384 mm, B = 400 mm	4002/6141 lx ¹	RLLQ 48 R	112 919 000 - 004 917 86	
NEW	14 W	Mains plug	100 – 240 V, 50/60 Hz	A = 384 mm, B = 400 mm Nonreflecting lens	4002/6141 lx ¹	RLLQ 48 R	112 919 000 - 005 489 59
14 W	Mains plug	100 – 240 V, 50/60 Hz	A = 384 mm, B = 400 mm Add-on lens 8 dpt	4002/6141 lx ¹	RLLQ 48 R	112 919 001 - 004 991 59	
14 W	Mains plug	100 – 240 V, 50/60 Hz	A = 384 mm, B = 400 mm Visualizer	4002/6141 lx ¹	RLLQ 48/2 R	112 919 002 - 004 991 64	
NEW	14 W	Mains plug	100 – 240 V, 50/60 Hz	A = 384 mm, B = 400 mm Nonreflecting lens, Visualizer	4002/6141 lx ¹	RLLQ 48/2 R	112 919 000 - 005 489 62
14 W	Mains plug	100 – 240 V, 50/60 Hz	A = 384 mm, B = 400 mm Add-on lens 8 dpt, Visualizer	4002/6141 lx ¹	RLLQ 48/2 R	112 919 003 - 004 991 70	

ESD DESIGN

CONSUMPTION	OPERATING DEVICE	CONNECTED LOAD	SPECIAL FEATURE	E_m/E_{max}^*	MODEL	ORDER NUMBER	
NEW	14 W	Mains plug	100 – 240 V, 50/60 Hz	A = 484 mm, B = 500 mm Visualizer	3089/4636 lx ¹	RLLQ 48/2 AR	113 015 000 - 005 61 675
NEW	14 W	Mains plug	100 – 240 V, 50/60 Hz	A = 384 mm, B = 400 mm Visualizer	3089/4636 lx ¹	RLLQ 48/2 AR	113 016 000 - 005 616 85

* E_m = Medium illuminance; E_{max} = Maximum illuminance; ¹ Measuring range 30 cm x 30 cm/Measuring distance 15 cm



pCon
PLANNER
efficient light

TEVISIO in ESD design

Features at a glance

- 48 x LED
- Color temperature neutral white 4,000 K
- Light control via reflector
- Glass lens Ø 160 mm with 3.5 diopters or 3.5 + 8 diopters (with a bonded, add-on lens)
- Housing made of colorless anodized or black-painted aluminum and black high-performance plastic satined polyamide screen
- Spring-balanced arm with 3D head joint
- Touch panel integrated in the luminaire head for On/Off, dimming and, where applicable, Visualizer function (segment switching)
- System of protection IP 20; class of protection II
- Supplied with 3.5 m mains lead and with mains plug type CEE 7/16 (Euro plug), BS 1363 and NEMA 1-15P
- Various fastenings and add-on magnifier (3.5 diopters) as accessories

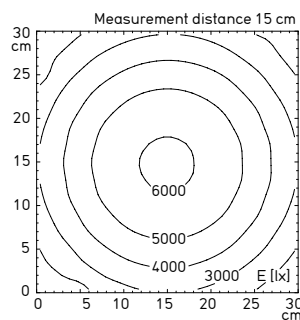
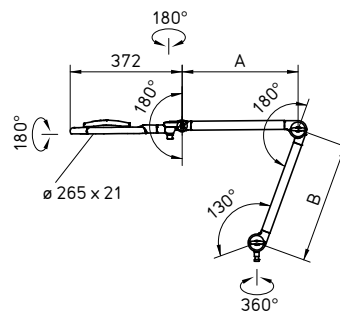

Illuminance 14 W
based on the example without
ESD design

Integrated
machine
luminaires



Surface-
mounted
luminaires



Tube
luminaires



Arm-mounted
luminaires

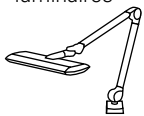

Flexible-tube
luminaires

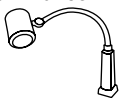

Pivoting-head
luminaires



Magnifier
luminaires

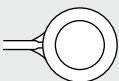

RING LED

AESTHETICS FOR THE WORKPLACE.



When miniature parts need to be inspected or precisely processed in mechanical engineering, research and development, attention to detail is vital. The RING LED has the perfect lens and the optimum light to meet these requirements: With six LEDs and a lens developed by Waldmann that compactly concentrates the light on the inspection area.

- Extremely efficient thanks to 4 x more light per Watt than conventional fluorescent lamps
- Distortion-free magnification right to the edge
- Intuitive, convenient operation on the luminaire head
- Low space requirements.
- Insensitive to vibrations
- Closed luminaire head as protection against dirt and damage
- Easy and fast to clean
- Maintenance-free: LED life of up to 50,000 hours and more

•••
LED



reddot design award
honourable mention 2009



efficient *light*

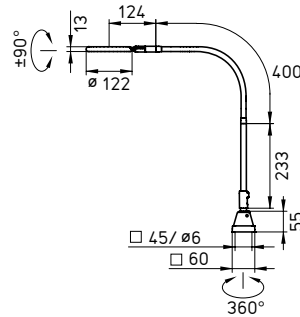

Features at a glance

- 6 x HIGH POWER LED
- Color temperature neutral white 4,000 K
- Light control by integrated optics
- Hard-coated plastic lens Ø 72 mm with 5.3 diopters
- Housing made of anodized aluminum and black plastic acrylic screen
- Head joint for individual adjustments
- Metal flexible tube for at least 20,000 movements
- With sensor switch in the luminaire head
- System of protection IP20; class of protection II
- Supplied with 2 m mains lead and with mains plug type CEE 7/16 (Euro plug), BS 1363 and NEMA 1-15P
- Various fastenings as accessories

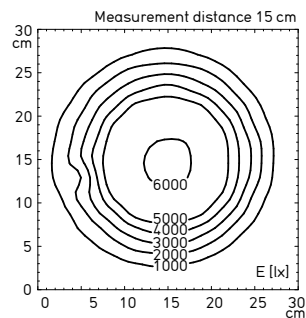

Illuminance 6 W

Integrated machine luminaires



Surface-mounted luminaires



Tube luminaires



Arm-mounted luminaires



Flexible-tube luminaires

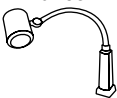

Pivoting-head luminaires



Magnifier luminaires

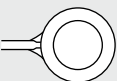

CONSUMPTION	OPERATING DEVICE	CONNECTED LOAD	SPECIAL FEATURE	E_m / E_{max}^*	MODEL	ORDER NO.
6 W	Mains plug	100 – 240 V, 50/60 Hz	–	2281/6190 lx ¹	RLLQ 6	112 885 000 - 000 249 59

* E_m = medium illuminance; E_{max} = maximum illuminance; ¹ Measuring range 30 cm x 30 cm / Measuring distance 15 cm

SNL/SNLE

PRECISION RIGHT DOWN TO THE VERY LAST DETAIL.



Where there is light, there is also shadow as long as you need an incidence of light with significant shadow to recognize certain details when using the SNL or SNLE. If, however, you need completely shadow-free light for assembly and inspection tasks, that's no problem either: This special magnifier luminaire range changes its lighting character with the flick of a switch.

- Extremely high illuminance
- Change of the lighting character by different settings of the illuminant for shadow-free light or light with shadow to highlight 3D structures
- Wide-range field of inspection
- Flexible luminaire head that is conveniently adjustable in all directions
- Low energy consumption
- Also available in ESD design

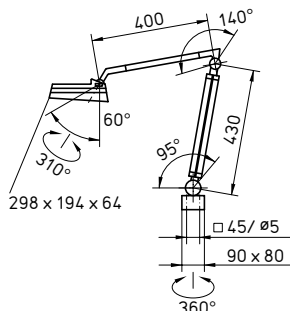

SNL in ESD design

Features at a glance

- TC-S or TC-SEL compact fluorescent lamps
- Color temperature neutral white 4,000 K
- Glare-free thanks to matt screen
- Pivoting glass lens 175 x 105 mm with 3 diopters
- Light gray or black plastic housing, plastic screen
- 3D ball joint head for individual settings
- Spring-balanced arm
- Several switch settings, switch in the luminaire head
- System of protection IP20; class of protection I
- Supplied with 3 m mains lead with plug type CEE 7/7 (shock-proof plug)
- Various fastenings and add-on magnifiers (4 diopters) as accessories

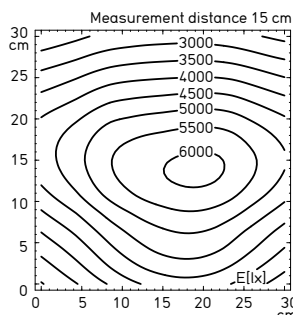

Illuminance 3 x 9 W based on the example without ESD design

Integrated machine luminaires

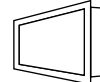

Surface-mounted luminaires

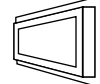

Tube luminaires



Arm-mounted luminaires

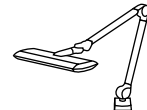

Flexible-tube luminaires

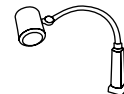

Pivoting-head luminaires



Magnifier luminaires

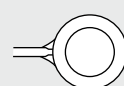

FITTED WITH	OPERATING DEVICE	CONNECTED LOAD	SPECIAL FEATURE	E_m/E_{max}^*	MODEL	ORDER NUMBER
3 x 9 WTC-S	Conventional ballast integrated	230 V, 50 Hz	-	4252/6096 lx ¹	SNL 319	111 961 000 - 000 651 01
3 x 9 WTC-SEL	Integrated electronic ballast	100/120/230 V, 50/60 Hz	-	4252/6096 lx ¹	SNLE 319	111 971 000 - 000 719 54

ESD DESIGN						
FITTED WITH	OPERATING DEVICE	CONNECTED LOAD	SPECIAL FEATURE	E_m/E_{max}^*	MODEL	ORDER NUMBER
3 x 9 WTC-S	Conventional ballast integrated	230 V, 50 Hz	-	3326/4914 lx ¹	SNL 319 A	112 128 000 - 000 835 24

* E_m = Medium illuminance; E_{max} = Maximum illuminance; ¹ Measuring range 30 cm x 30 cm / Measuring distance 15 cm

RLL

THE MAGNIFIER LUMINAIRE FOR EXPLORERS.

Trust is good – Control is better. And if you don't want to misplace your trust, the RLL is the right magnifier luminaire for you. Quite simply because it provides distortion-free magnification of objects with minimal dimensions and clearly illuminates them for visual inspection.

- Shadow-free illumination
- Bright and efficient
- With distortion-free lens
- Easy to reach switch in the luminaire head



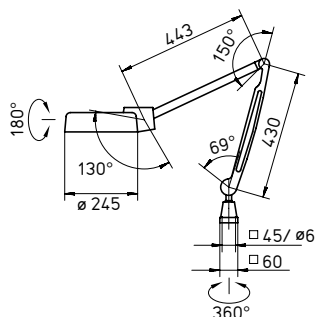

Features at a glance

- T29-R fluorescent lamp
- Color temperature neutral white 4,300 K
- Glare-free thanks to white opal screen
- Glass lens Ø 120 mm with 4 or 4 + 8 diopters (stuck on add-on lens)
- Light gray plastic housing, polycarbonate screen
- Spring-balanced arm
- With switch in the luminaire head
- System of protection IP20; class of protection II
- Supplied with 3 m mains lead with plug type CEE 7/16 (Euro plug)
- Various fastenings and add-on magnifier (4 diopters) as accessories

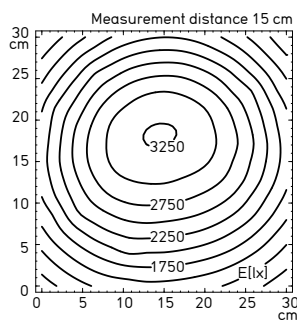

Illuminance 1 x 22 W

Integrated machine luminaires

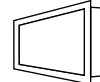

Surface-mounted luminaires

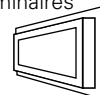

Tube luminaires



Arm-mounted luminaires



Flexible-tube luminaires

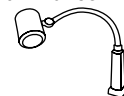

Pivoting-head luminaires



Magnifier luminaires

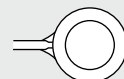

FITTED WITH	OPERATING DEVICE	CONNECTED LOAD	SPECIAL FEATURE	E_m / E_{max}^*	MODEL	ORDER NO.
1 x 22 WT29-R	Conventional ballast integr.	230 V, 50 Hz	4 diopter lens	2162/3255 lx ¹	RLL 122 T	111 851 000 - 000 648 69
1 x 22 WT29-R	Conventional ballast integr.	230 V, 50 Hz	4 diopter lens + 8 diopter add-on lens	2162/3255 lx ¹	RLL 122 T	111 851 001 - 000 648 70

* E_m = medium illuminance; E_{max} = maximum illuminance; ¹ Measuring range 30 cm x 30 cm / Measuring distance 15 cm

WORKPLACE-SYSTEM LUMINAIRES

Workplace-system Luminaires are ideal for the lighting of industrial workplaces. Depending on the type and structure of the workplace, the luminaire modules are used individually or in a combination.





TANEO

NEW



IP20

132 - 133

Integrated machine luminaires



NEW



IP20

134 - 135

Surface-mounted luminaires



TAMETO

NEW



IP20

136 - 137

Tube luminaires



NEW



IP20

138 - 139

Arm-mounted luminaires

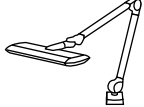

NEW



IP20

140 - 141

Flexible-tube luminaires



NEW



IP20

142 - 143

Pivoting-head luminaires



Magnifier luminaires

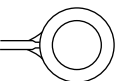

Workplace-system luminaires



TANEO

NEW

CONVENIENT SWIVELING – FLEXIBLE LIGHTING.



Thanks to its handy arm, this TANEO luminaire variant can be rotated horizontally. This innovative connection enables e.g. lateral illumination and thus shadow-free working in any task position. It is ideally used as a pair of luminaires. The luminaire head can also be rotated. TANEO thus guarantees the correct lighting at all times, even when different tasks have to be performed at a single work station.

- Maintenance-free LED technology with a service life of up to 50,000 hours and more
- 30 % energy savings
- Continuously dimmable down to 10 %, with memory function
- Light Forming and Ray Mixing Technology for area light that is free from shadows and reflective glare
- Glare-free thanks to conical prismatic screen (CDP) or white opal screen
- Flicker-free light with no IR or UV content
- Good contrast sensitivity and very good color recognition thanks to premium LEDs
- Robust aluminum and fiberglass-reinforced high-performance plastic
- Also available in ESD design



TANE0 in ESD design

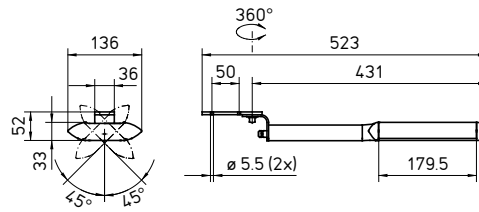

Features at a glance

- 12 x LED
- Color temperature neutral white 4,000 K or 5,000 K
- Glare-free thanks to conical prismatic screen (CDP) or white opal screen
- Housing made of colorless anodized or black-painted aluminum and black plastic, screen made of PMMA (CDP) or PC (white opal screen)
- Swivel arm with rotatable head joint
- Touch panel integrated in the luminaire head for On/Off and dimming
- System of protection IP20; class of protection II
- Supplied with 4 m mains lead and with mains plug type CEE 7/16 (Euro plug)

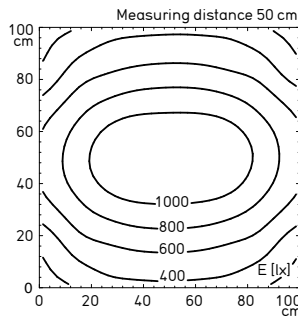

Illuminance based on the example of two 15 W luminaires with CDP screen without ESD design rotated by 90° (distance between the two luminaire heads approx. 90 cm)

Integrated machine luminaires



Surface-mounted luminaires



Tube luminaires



Arm-mounted luminaires



Flexible-tube luminaires

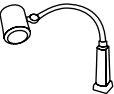

Pivoting-head luminaires



Magnifier luminaires

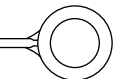

Workplace-system luminaires

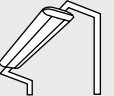

100 – 240 V, 50/60 HZ						
CONSUMPTION	OPERATING DEVICE	DIMENSIONS	SPECIAL FEATURE	E_m/E_{max}^*	MODEL	ORDER NUMBER
15 W	Mains plug	179.5 x 136 mm	CDP screen, 4,000 K	563/1569 lx ¹	SARKL 12 R	112 991 000 - 005 525 84
15 W	Mains plug	179.5 x 136 mm	CDP screen, 5,000 K	563/1569 lx ¹	SARKL 12 R	112 991 000 - 005 592 47
15 W	Mains plug	179.5 x 136 mm	White opal screen, 4,000 K	361/816 lx ¹	SARKL 12 R	112 991 000 - 005 592 50
15 W	Mains plug	179.5 x 136 mm	White opal screen, 5,000 K	361/816 lx ¹	SARKL 12 R	112 991 000 - 005 592 53

100 – 240 V, 50/60 HZ, ESD DESIGN						
CONSUMPTION	OPERATING DEVICE	DIMENSIONS	SPECIAL FEATURE	E_m/E_{max}^*	MODEL	ORDER NUMBER
15 W	Mains plug	179.5 x 136 mm	CDP screen, 4,000 K	490/1346 lx ¹	SARKL 12 AR	113 021 000 - 005 645 65
15 W	Mains plug	179.5 x 136 mm	CDP screen, 5,000 K	490/1346 lx ¹	SARKL 12 AR	113 021 000 - 005 645 68

* E_m = Medium illuminance; E_{max} = Maximum illuminance; ¹ Measuring range 100 cm x 100 cm/Measuring distance 50 cm
Also available as an arm-mounted luminaire.

TANEO

NEW

SPACE-SAVING YET VERSATILE.



LED

The TANEO workplace-system luminaire offers particularly space-saving and unobtrusive assembly options, e.g. under shelves. Thanks to its rotatable luminaire head, it is also flexible. Its dimmability means that it can easily be adjusted to individual requirements.

At the same time, its high-quality light reduces eye strain when working.

- Maintenance-free LED technology with a service life of up to 50,000 hours and more
- Requirements-oriented output levels for up to 4,000 lux
- 30 % energy savings
- Glare-free thanks to conical prismatic screen (CDP) or white opal screen
- Continuously dimmable down to 10 %, with memory function
- Light Forming and Ray Mixing Technology for area light that is free from shadows and reflective glare
- Flicker-free light with no IR or UV content
- Good contrast sensitivity and very good color recognition thanks to premium LEDs
- Robust aluminum and fiberglass-reinforced high-performance plastic
- Also available in ESD design



pCon
PLANNER
efficient light

TANE0 in ESD design

Features at a glance

- 12, 24 or 36 x LED
- Color temperature neutral white 4,000 K or 5,000 K
- Glare-free thanks to conical prismatic screen (CDP) or white opal screen
- Housing made of colorless anodized or black-painted aluminum and black plastic, screen made of PMMA (CDP) or PC (white opal screen)
- Fixed connection with rotatable head joint
- Touch panel integrated in the luminaire head for On/Off and dimming
- System of protection IP20; class of protection II
- Supplied with 6 m mains lead and table power supply with plug type CEE 7/16 (Euro plug)

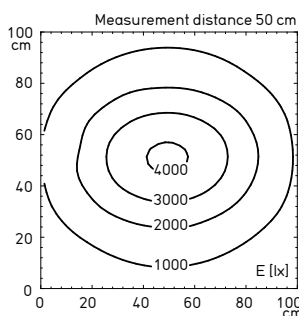
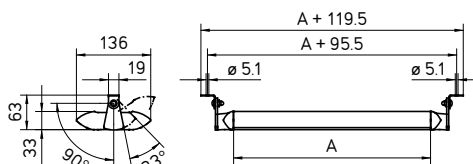

Illuminance based on the example 47 W with CDP screen

Integrated machine luminaires

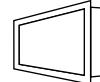

Surface-mounted luminaires

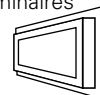

Tube luminaires



Arm-mounted luminaires



Flexible-tube luminaires



Pivoting-head luminaires



Magnifier luminaires

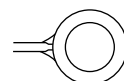

Workplace-system luminaires



100 – 240 V, 50/60 HZ

CONSUMPTION	OPERATING DEVICE	DIMENSIONS	SPECIAL FEATURE	E_m/E_{max}^*	MODEL	ORDER NUMBER
31 W	Table power supply	A = 359.5 x 136 mm	CDP screen, 4,000 K	1137/3053 lx ¹	SARL 24 R	112 992 000 - 005 525 87
31 W	Table power supply	A = 359.5 x 136 mm	CDP screen, 5,000 K	1137/3053 lx ¹	SARL 24 R	112 992 000 - 005 593 08
31 W	Table power supply	A = 359.5 x 136 mm	White opal screen, 4,000 K	725/1578 lx ¹	SARL 24 R	112 992 000 - 005 593 11
31 W	Table power supply	A = 359.5 x 136 mm	White opal screen, 5,000 K	725/1578 lx ¹	SARL 24 R	112 992 000 - 005 593 15
47 W	Table power supply	A = 538.5 x 136 mm	CDP screen, 4,000 K	1641/4046 lx ¹	SARL 36 R	112 993 000 - 005 525 93
47 W	Table power supply	A = 538.5 x 136 mm	CDP screen, 5,000 K	1641/4046 lx ¹	SARL 36 R	112 993 000 - 005 593 18
47 W	Table power supply	A = 538.5 x 136 mm	White opal screen, 4,000 K	1082/2219 lx ¹	SARL 36 R	112 993 000 - 005 593 21
47 W	Table power supply	A = 538.5 x 136 mm	White opal screen, 5,000 K	1082/2219 lx ¹	SARL 36 R	112 993 000 - 005 594 45

100 – 240 V, 50/60 HZ, ESD DESIGN

CONSUMPTION	OPERATING DEVICE	DIMENSIONS	SPECIAL FEATURE	E_m/E_{max}^*	MODEL	ORDER NUMBER
31 W	Table power supply	A = 359.5 x 136 mm	CDP screen, 4,000 K	1016/2671 lx ¹	SARL 24 AR	113 022 000 - 005 645 71
31 W	Table power supply	A = 359.5 x 136 mm	CDP screen, 5,000 K	1016/2671 lx ¹	SARL 24 AR	113 022 000 - 005 645 75

* E_m = Medium illuminance; E_{max} = Maximum illuminance; ¹ Measuring range 100 cm x 100 cm / Measuring distance 50 cm
Also available as an arm-mounted luminaire

TAMETO

NEW

ERGONOMIC SYSTEMATIC LIGHTING.



TAMETO is available with state-of-the-art T16 fluorescent lamp technology or the latest LED technology. It also offers a range of installation options.

- Extremely homogeneous, glare-free, flicker-free light
- Continuously dimmable (variants) down to 10 %, with memory function
- Particularly durable lamp types with a service life of up to 24,000 hours (T16) or 50,000 hours (LED) and more
- Various lengths for different table widths and lighting needs
- Through-wiring for electrical daisy-chaining of several luminaires (variants)
- Closed construction protects the inside of the luminaire and keeps the work surface clean
- Extremely robust aluminum housing
- Integrated T-slots
- Up to 60 % energy savings

Features at a glance

- T16 fluorescent lamp or 2, 3 or 4 x LED lamps
- Color temperature neutral white 4,000 K (other color temperatures on request)
- Glare-free thanks to the conical prismatic screen (CDP) or aluminized parabolic louver (T16)
- Housing made of colorless anodized aluminum and black plastic, screen made of PMMA or parabolic louver made of ABS
- Mounting by means of mounting frames or T-slots (8 mm)
- With switch or additionally continuously dimmable (external dimming on request)
- System of protection IP20, class of protection I
- Supplied with 3 m mains lead and plug type CEE 7/7 (shock-proof plug) or Wieland GST18/3 plug/bushing for through-wired variants
- Clear PMMA screen for insertion over the parabolic louver, pair of luminaire brackets for flexible mounting on C-rails and cables for connecting through-wired luminaires as accessories

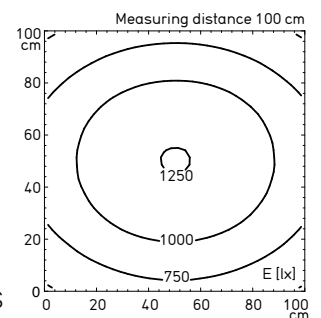

Illuminance based on the example 33 W LED



pCon
PLANNER
efficient light

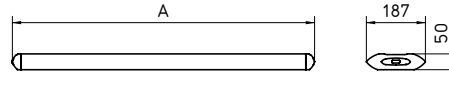

Integrated machine luminaires



Surface-mounted luminaires



Tube luminaires



Arm-mounted luminaires

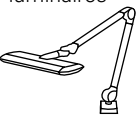

Flexible-tube luminaires



Pivoting-head luminaires



Magnifier luminaires

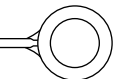

Workplace-system luminaires



220 – 240 V, 50/60 HZ

CONSUMPTION	OPERATING DEVICE	DIMENSIONS	SPECIAL FEATURE	E_m/E_{max}^*	MODEL	ORDER NUMBER
23 W LED	Driver integrated	A = 656 x 187 mm	CDP screen	606/841 lx ¹	SAHQ 44	112 971 000 - 005 513 37
23 W LED	Driver integrated	A = 656 x 187 mm	CDP screen, through-wired	606/841 lx ¹	SAHQ 44 D	112 971 000 - 005 555 76
23 W LED	Driver integrated	A = 656 x 187 mm	CDP screen, dimmable	606/841 lx ¹	SAHQ 44 R	112 972 000 - 005 513 40
23 W LED	Driver integrated	A = 656 x 187 mm	CDP screen, dimmable, through-wired	606/841 lx ¹	SAHQ 44 RD	112 972 000 - 005 555 80
33 W LED	Driver integrated	A = 956 x 187 mm	CDP screen	922/1254 lx ¹	SAHQ 66	112 975 000 - 005 513 49
33 W LED	Driver integrated	A = 956 x 187 mm	CDP screen, through-wired	922/1254 lx ¹	SAHQ 66 D	112 975 000 - 005 556 28
33 W LED	Driver integrated	A = 956 x 187 mm	CDP screen, dimmable	922/1254 lx ¹	SAHQ 66 R	112 976 000 - 005 513 52
33 W LED	Driver integrated	A = 956 x 187 mm	CDP screen, dimmable, through-wired	922/1254 lx ¹	SAHQ 66 RD	112 976 000 - 005 556 31
43 W LED	Driver integrated	A = 1256 x 187 mm	CDP screen	1139/1509 lx ¹	SAHQ 88	112 979 000 - 005 513 61
43 W LED	Driver integrated	A = 1256 x 187 mm	CDP screen, through-wired	1139/1509 lx ¹	SAHQ 88 D	112 979 000 - 005 556 94
43 W LED	Driver integrated	A = 1256 x 187 mm	CDP screen, dimmable	1139/1509 lx ¹	SAHQ 88 R	112 980 000 - 005 513 64
43 W LED	Driver integrated	A = 1256 x 187 mm	CDP screen, dimmable, through-wired	1139/1509 lx ¹	SAHQ 88 RD	112 980 000 - 005 556 97

220 – 240 V, 50/60 HZ

FITTED WITH	OPERATING DEVICE	DIMENSIONS	SPECIAL FEATURE	E_m/E_{max}^*	MODEL	ORDER NUMBER
1 x 24 WT16	Integr. electronic ballast	A = 656 x 187 mm	CDP screen	499/685 lx ¹	SAH 124	112 969 000 - 005 506 62
1 x 24 WT16	Integr. electronic ballast	A = 656 x 187 mm	Parabolic louver	408/567 lx ¹	SAH 124	112 969 000 - 005 558 04
1 x 24 WT16	Integr. electronic ballast	A = 656 x 187 mm	CDP screen, through-wired	499/685 lx ¹	SAH 124 D	112 969 000 - 005 558 07
1 x 24 WT16	Integr. electronic ballast	A = 656 x 187 mm	Parabolic louver, through-wired	408/567 lx ¹	SAH 124 D	112 969 000 - 005 558 10
1 x 24 WT16	Integr. electronic ballast	A = 656 x 187 mm	CDP screen, dimmable	499/685 lx ¹	SAH 124 R	112 970 000 - 005 558 14
1 x 24 WT16	Integr. electronic ballast	A = 656 x 187 mm	Parabolic louver, dimmable	408/567 lx ¹	SAH 124 R	112 970 000 - 005 558 17
1 x 24 WT16	Integr. electronic ballast	A = 656 x 187 mm	CDP screen, dimmable, through-wired	499/685 lx ¹	SAH 124 RD	112 970 000 - 005 558 20
1 x 24 WT16	Integr. electronic ballast	A = 656 x 187 mm	Parabolic louver, dimmable, through-wired	408/567 lx ¹	SAH 124 RD	112 970 000 - 005 558 23
1 x 39 WT16	Integr. electronic ballast	A = 956 x 187 mm	CDP screen	915/1229 lx ¹	SAH 139	112 973 000 - 005 560 17
1 x 39 WT16	Integr. electronic ballast	A = 956 x 187 mm	Parabolic louver	734/1000 lx ¹	SAH 139	112 973 000 - 005 560 20
1 x 39 WT16	Integr. electronic ballast	A = 956 x 187 mm	CDP screen, through-wired	915/1229 lx ¹	SAH 139 D	112 973 000 - 005 560 23
1 x 39 WT16	Integr. electronic ballast	A = 956 x 187 mm	Parabolic louver, through-wired	734/1000 lx ¹	SAH 139 D	112 973 000 - 005 560 26
1 x 39 WT16	Integr. electronic ballast	A = 956 x 187 mm	CDP screen, dimmable	915/1229 lx ¹	SAH 139 R	112 974 000 - 005 561 46
1 x 39 WT16	Integr. electronic ballast	A = 956 x 187 mm	Parabolic louver, dimmable	734/1000 lx ¹	SAH 139 R	112 974 000 - 005 561 49
1 x 39 WT16	Integr. electronic ballast	A = 956 x 187 mm	CDP screen, dimmable, through-wired	915/1229 lx ¹	SAH 139 RD	112 974 000 - 005 561 52
1 x 39 WT16	Integr. electronic ballast	A = 956 x 187 mm	Parabolic louver, dimmable, through-wired	734/1000 lx ¹	SAH 139 RD	112 974 000 - 005 561 55
1 x 54 WT16	Integr. electronic ballast	A = 1256 x 187 mm	CDP screen	1270/1709 lx ¹	SAH 154	112 977 000 - 005 561 71
1 x 54 WT16	Integr. electronic ballast	A = 1256 x 187 mm	Parabolic louver	1014/1371 lx ¹	SAH 154	112 977 000 - 005 561 74
1 x 54 WT16	Integr. electronic ballast	A = 1256 x 187 mm	CDP screen, through-wired	1270/1709 lx ¹	SAH 154 D	112 977 000 - 005 561 77
1 x 54 WT16	Integr. electronic ballast	A = 1256 x 187 mm	Parabolic louver, through-wired	1014/1371 lx ¹	SAH 154 D	112 977 000 - 005 561 80
1 x 54 WT16	Integr. electronic ballast	A = 1256 x 187 mm	CDP screen, dimmable	1270/1709 lx ¹	SAH 154 R	112 978 000 - 005 561 86
1 x 54 WT16	Integr. electronic ballast	A = 1256 x 187 mm	Parabolic louver, dimmable	1014/1371 lx ¹	SAH 154 R	112 978 000 - 005 561 89
1 x 54 WT16	Integr. electronic ballast	A = 1256 x 187 mm	CDP screen, dimmable, through-wired	1270/1709 lx ¹	SAH 154 RD	112 978 000 - 005 561 92
1 x 54 WT16	Integr. electronic ballast	A = 1256 x 187 mm	Parabolic louver, dimmable, through-wired	1014/1371 lx ¹	SAH 154 RD	112 978 000 - 005 561 95

* E_m = Medium illuminance; E_{max} = Maximum illuminance; ¹ Measuring range 100 cm x 100 cm/Measuring distance 100 cm

TAMETO

NEW

FITS PRECISELY WHERE IT NEEDS TO.



Special variants in three lengths are available for accurate integration of the lighting between the crossbeams. Through-wiring facilitates connection to daisy-chained work stations.

- Extremely homogeneous, glare-free, flicker-free light
- Continuously dimmable (variants) down to 10 %, with memory function
- With options for state-of-the-art T16 fluorescent lamps or LED technology
- Particularly durable lamp types with a service life of up to 24,000 hours (T16) or 50,000 hours (LED) and more
- Closed construction protects the inside of the luminaire and keeps the work surface clean
- Extremely robust aluminum housing
- Up to 60 % energy savings



pCon
PLANNER
efficient light

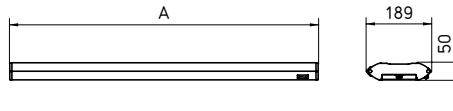

Features at a glance

- T16 fluorescent lamp or 2, 3 or 4 x LED lamps
- Color temperature neutral white 4,000 K (other color temperatures on request)
- Glare-free thanks to conical prismatic screen (CDP)
- Housing made of colorless anodized aluminum and black plastic, screen made of PMMA
- Mounting by means of mounting frames or T-slots (8 mm)
- With switch or additionally continuously dimmable (external dimming on request)
- System of protection IP20, class of protection I
- Supplied with integrated Wieland GST18/3 plug/bushing
- Cables for connecting multiple luminaires as accessories

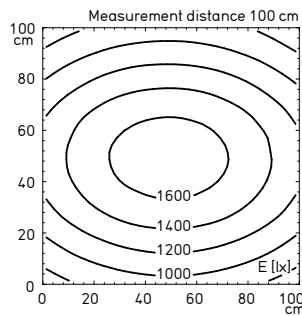

Illuminance based on the example
1 x 54 WT16

Integrated machine luminaires



Surface-mounted luminaires



Tube luminaires



Arm-mounted luminaires



Flexible-tube luminaires



Pivoting-head luminaires



Magnifier luminaires

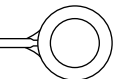

Workplace-system luminaires

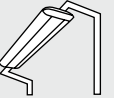

220 – 240 V, 50/60 HZ

CONSUMPTION	OPERATING DEVICE	DIMENSIONS	SPECIAL FEATURE	E_m/E_{max}^*	MODEL	ORDER NUMBER
23 W LED	Driver integrated	A = 599 x 189 mm	CDP screen, through-wired	606/841 lx ¹	SAHQ 44 D	113 034 000 - 005 776 11
23 W LED	Driver integrated	A = 599 x 189 mm	CDP screen, dimmable, through-wired	606/841 lx ¹	SAHQ 44 RD	113 035 000 - 005 776 14
33 W LED	Driver integrated	A = 899 x 189 mm	CDP screen, through-wired	922/1254 lx ¹	SAHQ 66 D	113 036 000 - 005 776 17
33 W LED	Driver integrated	A = 899 x 189 mm	CDP screen, dimmable, through-wired	922/1254 lx ¹	SAHQ 66 RD	113 037 000 - 005 776 20
43 W LED	Driver integrated	A = 1199 x 189 mm	CDP screen, through-wired	1139/1509 lx ¹	SAHQ 88 D	113 038 000 - 005 776 23
43 W LED	Driver integrated	A = 1199 x 189 mm	CDP screen, dimmable, through-wired	1139/1509 lx ¹	SAHQ 88 RD	113 039 000 - 005 776 26

220 – 240 V, 50/60 HZ

FITTED WITH	OPERATING DEVICE	DIMENSIONS	SPECIAL FEATURE	E_m/E_{max}^*	MODEL	ORDER NUMBER
1 x 24 WT16	Integr. electronic ballast	A = 599 x 189 mm	CDP screen, through-wired	499/685 lx ¹	SAH 124 D	113 029 000 - 005 775 95
1 x 24 WT16	Integr. electronic ballast	A = 599 x 189 mm	CDP screen, dimmable, through-wired	499/685 lx ¹	SAH 124 RD	113 030 000 - 005 775 99
1 x 39 WT16	Integr. electronic ballast	A = 899 x 189 mm	CDP screen, through-wired	915/1229 lx ¹	SAH 139 D	113 024 000 - 005 684 47
1 x 39 WT16	Integr. electronic ballast	A = 899 x 189 mm	CDP screen, dimmable, through-wired	915/1229 lx ¹	SAH 139 RD	113 031 000 - 005 776 02
1 x 54 WT16	Integr. electronic ballast	A = 1199 x 189 mm	CDP screen, through-wired	1270/1709 lx ¹	SAH 154 D	113 032 000 - 005 776 05
1 x 54 WT16	Integr. electronic ballast	A = 1199 x 189 mm	CDP screen, dimmable, through-wired	1270/1709 lx ¹	SAH 154 RD	113 033 000 - 005 776 08

* E_m = Medium illuminance; E_{max} = Maximum illuminance; ¹ Measuring range 100 cm x 100 cm/Measuring distance 100 cm

TAMETO

NEW

THE RIGHT SETTING TO WORK ERGONOMICALLY.



Suspended mounting is the first choice when a continuously height-adjustable workplace-system luminaire is required. TAMETO is mounted by means of a counterweight pendant on the top crossbeam of the system work station. Depending on individual lighting needs and the visual task, it can be set to the optimum height. The handling is especially easy and the variable-length spiral cable ensures a tidy appearance.

- Extremely homogeneous, glare-free, flicker-free light
- Continuously dimmable (variants) down to 10 %, with memory function
- With options for state-of-the-art T16 fluorescent lamps or LED technology
- Particularly durable lamp types with a service life of up to 24,000 hours (T16) or 50,000 hours (LED) and more
- Two lengths for different table widths and lighting needs
- Closed construction protects the inside of the luminaire and keeps the work surface clean
- Extremely robust aluminum housing
- Up to 60 % energy savings
- Also available in ESD design



pCon
PLANNER
efficient light

TAMETO in ESD design

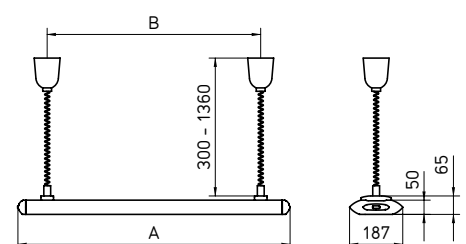



Features at a glance

- T16 fluorescent lamp or 3 or 4 x LED lamps
- Color temperature neutral white 4,000 K (other color temperatures on request)
- Glare-free thanks to the conical prismatic screen (CDP) or aluminized parabolic louver (T16)
- Housing made of colorless anodized or black-painted aluminum and black plastic, screen made of PMMA or parabolic louver made of ABS
- Integration by means of a counterweight pendant with an extension length of 0.3 – 1.36 m
- With switch or, additionally, continuously dimmable
- System of protection IP20, class of protection I
- Supplied without connecting cable
- Clear PMMA screen for insertion over the parabolic louver as an accessory

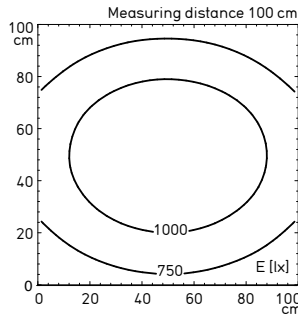

Illuminance based on the example
1 x 39 W T16 with CDP screen without ESD design

Integrated machine luminaires



Surface-mounted luminaires



Tube luminaires



Arm-mounted luminaires

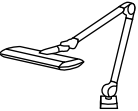

Flexible-tube luminaires

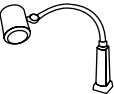

Pivoting-head luminaires



Magnifier luminaires

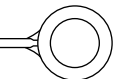

Workplace-system luminaires

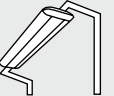

220 – 240 V, 50/60 HZ

CONSUMPTION	OPERATING DEVICE	DIMENSIONS	SPECIAL FEATURE	E_m/E_{max}^*	MODEL	ORDER NUMBER
33 W LED	Driver integrated	A = 956 x 187 mm B = 750 mm	CDP screen	922/1254 lx ¹	SAHZQ 66	112 983 000 - 005 513 73
33 W LED	Driver integrated	A = 956 x 187 mm B = 750 mm	CDP screen, dimmable	922/1254 lx ¹	SAHZQ 66 R	112 984 000 - 005 513 77
43 W LED	Driver integrated	A = 1256 x 187 mm B = 1050 mm	CDP screen	1139/1509 lx ¹	SAHZQ 88	112 987 000 - 005 513 86
43 W LED	Driver integrated	A = 1256 x 187 mm B = 1050 mm	CDP screen, dimmable	1139/1509 lx ¹	SAHZQ 88 R	112 988 000 - 005 513 89

220 – 240 V, 50/60 HZ, ESD DESIGN

CONSUMPTION	OPERATING DEVICE	DIMENSIONS	SPECIAL FEATURE	E_m/E_{max}^*	MODEL	ORDER NUMBER
33 W LED	Driver integrated	A = 956 x 187 mm B = 750 mm	CDP screen	806/1092 lx ¹	SAHZQ 66 A	113 026 000 - 005 746 37

220 – 240 V, 50/60 HZ

FITTED WITH	OPERATING DEVICE	DIMENSIONS	SPECIAL FEATURE	E_m/E_{max}^*	MODEL	ORDER NUMBER
1 x 39 WT16	Integrated electronic ballast	A = 956 x 187 mm B = 750 mm	CDP screen	915/1229 lx ¹	SAHZ 139	112 981 000 - 005 513 67
1 x 39 WT16	Integrated electronic ballast	A = 956 x 187 mm B = 750 mm	Parabolic louver	734/1000 lx ¹	SAHZ 139	112 981 000 - 005 557 00
1 x 39 WT16	Integrated electronic ballast	A = 956 x 187 mm B = 750 mm	CDP screen, dimmable	915/1229 lx ¹	SAHZ 139 R	112 982 000 - 005 513 70
1 x 39 WT16	Integrated electronic ballast	A = 956 x 187 mm B = 750 mm	Parabolic louver, dimmable	734/1000 lx ¹	SAHZ 139 R	112 982 000 - 005 557 03
1 x 54 WT16	Integrated electronic ballast	A = 1256 x 187 mm B = 1050 mm	CDP screen	1270/1709 lx ¹	SAHZ 154	112 985 000 - 005 513 80
1 x 54 WT16	Integrated electronic ballast	A = 1256 x 187 mm B = 1050 mm	Parabolic louver	1014/1371 lx ¹	SAHZ 154	112 985 000 - 005 557 06
1 x 54 WT16	Integrated electronic ballast	A = 1256 x 187 mm B = 1050 mm	CDP screen, dimmable	1270/1709 lx ¹	SAHZ 154 R	112 986 000 - 005 513 83
1 x 54 WT16	Integrated electronic ballast	A = 1256 x 187 mm B = 1050 mm	Parabolic louver, dimmable	1014/1371 lx ¹	SAHZ 154 R	112 986 000 - 005 557 09

220 – 240 V, 50/60 HZ, ESD DESIGN

FITTED WITH	OPERATING DEVICE	DIMENSIONS	SPECIAL FEATURE	E_m/E_{max}^*	MODEL	ORDER NUMBER
1 x 39 WT16	Integrated electronic ballast	A = 956 x 187 mm B = 750 mm	CDP screen	814/1084 lx ¹	SAHZ 139 A	113 027 000 - 005 746 40

* E_m = Medium illuminance; E_{max} = Maximum illuminance; ¹ Measuring range 100 cm x 100 cm/Measuring distance 100 cm

TAMETO

NEW

AN EXTRA HELPING OF LIGHT.



LED



With lateral mounting of TAMETO luminaires, completely shadow-free illumination or a desired shadow effect can be achieved. This can, for example, make fine surface irregularities visible.

Of course, lateral luminaires are also suitable if more light is needed for certain visual tasks.

TAMETO luminaires for lateral mounting are mounted at the desired height and at the desired angle of illumination on the vertical pillars of the system workstation using the supplied mounting brackets.

- Extremely homogeneous, glare-free, flicker-free light

- Maintenance-free LED technology with a service life of up to 50,000 hours and more
- Closed construction protects the inside of the luminaire and keeps the work surface clean
- Extremely robust aluminum housing
- Up to 60 % energy savings
- Also available in ESD design

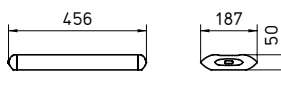

TAMETO in ESD design

Features at a glance

- 2 x LED lamps
- Color temperature neutral white 4,000 K (other color temperatures on request)
- Glare-free thanks to conical prismatic screen (CDP)
- Housing made of colorless anodized or black-painted aluminum and black plastic, screen made of PMMA
- Mounted by means of a mounting bracket
- With switch
- System of protection IP20, class of protection I
- Supplied with 3 m mains lead with plug type CEE 7/7 (shock-proof plug)
- Additional bracket as an accessory for an assembly on the top crossbeam that can be rotated

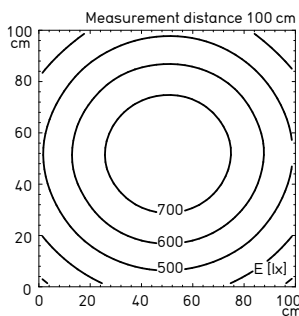

Illuminance based on the example without ESD design

Integrated machine luminaires

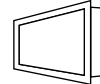

Surface-mounted luminaires

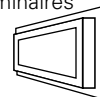

Tube luminaires



Arm-mounted luminaires

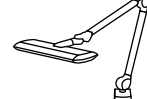

Flexible-tube luminaires



Pivoting-head luminaires



Magnifier luminaires

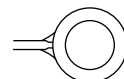

Workplace-system luminaires



220 – 240 V, 50/60 HZ

CONSUMPTION	OPERATING DEVICE	DIMENSIONS	SPECIAL FEATURE	E_m/E_{max}^*	MODEL	ORDER NUMBER
23 W LED	Driver integrated	456 x 187 mm	CDP screen	572/778 lx ¹	SAHKQ 60	112 989 000 - 005 513 92

220 – 240 V, 50/60 HZ, ESD DESIGN

CONSUMPTION	OPERATING DEVICE	DIMENSIONS	SPECIAL FEATURE	E_m/E_{max}^*	MODEL	ORDER NUMBER
23 W LED	Driver integrated	456 x 187 mm	CDP screen	496/675 lx ¹	SAHKQ 60 A	113 028 000 - 005 750 17

* E_m = Medium illuminance; E_{max} = Maximum illuminance; ¹ Measuring range 100 cm x 100 cm / Measuring distance 100 cm

INSPECTION LUMINAIRES

Inspection luminaires provide quality assurance for a wide range of sectors thanks to the right inspection light. The visual inspection is supported by wide-range, shadow-free light with optimum color reproduction in the daylight spectrum.

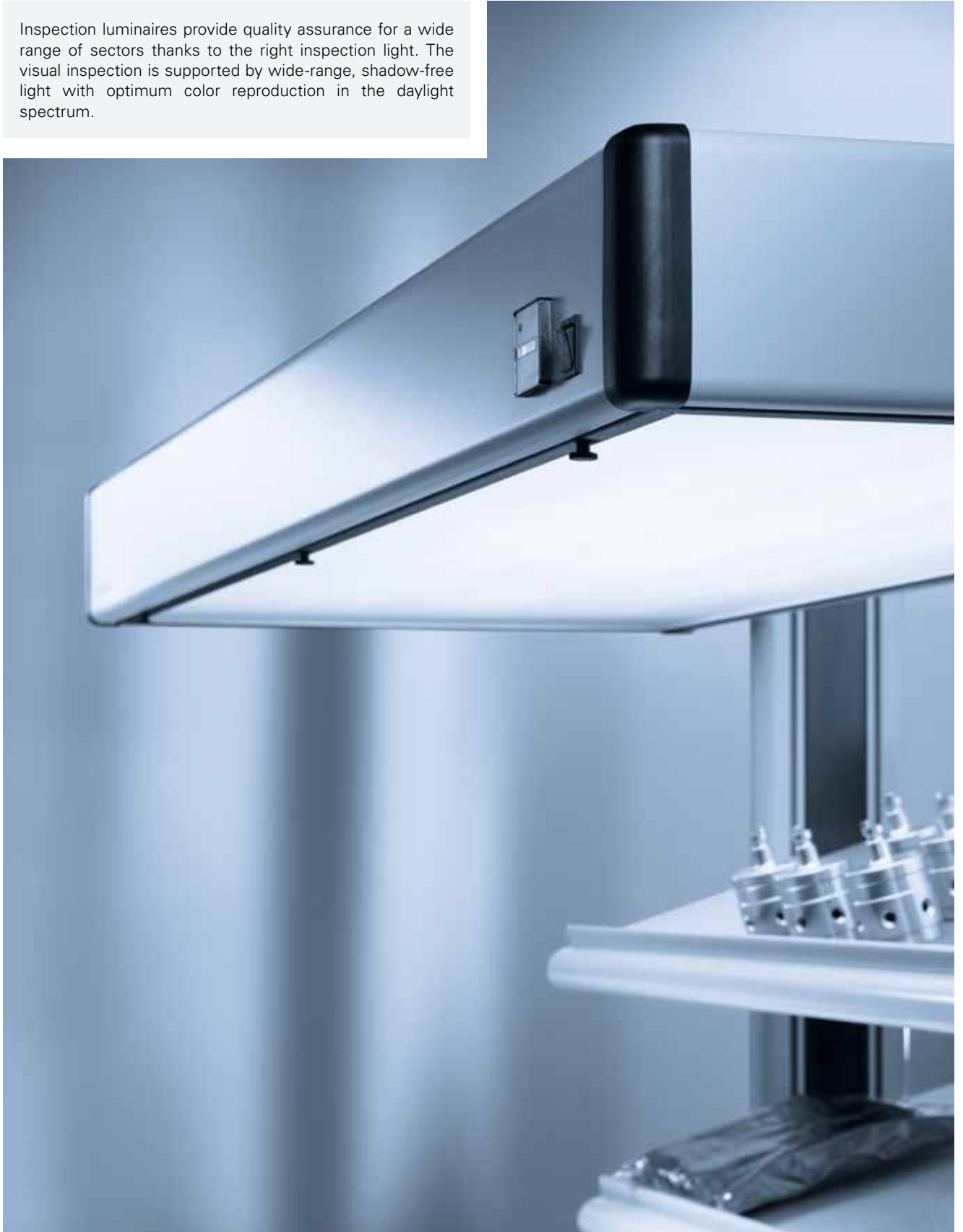

ALE



146 - 147

Integrated machine luminaires

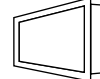

Surface-mounted luminaires

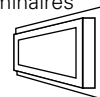

Tube luminaires



Arm-mounted luminaires



Flexible-tube luminaires



Pivoting-head luminaires



Magnifier luminaires

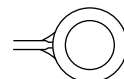

Workplace-system luminaires



Inspection luminaires



ALE

BRILLIANT INSPECTION LIGHT FOR EXCELLENT RESULTS.

There are fields in which premium color fidelity and surface quality are key: For example, in the printing or the textiles industry. That's why the standardized ALE inspection light ensures that visual inspections can be carried out without undesirable metameric effects or other disruptive influences.

- Optimum color reproduction in the daylight spectrum
- Error-free inspection on high-gloss surfaces
- Particularly bright, wide-range and even illumination
- Also suitable for use in laboratories



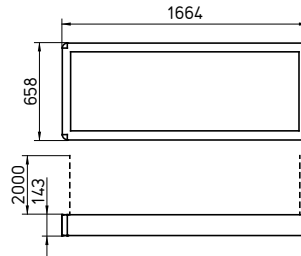

Features at a glance

- T26 fluorescent lamps
- Color temperature daylight white 5,300 K
- Glare-free thanks to structured screen
- Gray painted steel housing, acrylic screen
- Chain-mounted
- With switch and integrated timer
- System of protection IP20; class of protection I
- Supplied with 5 m mains lead and free stranded wires

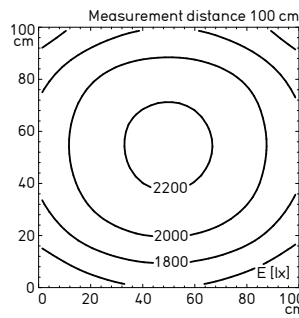

Illuminance 4 x 58 W

220 – 240 V, 50/60 HZ

FITTED WITH	OPERATING DEVICE	DIMENSIONS	SPECIAL FEATURE	E_m / E_{max}^*	MODEL	ORDER NO.
4 x 58 WT26	Integr. electronic ballast	1664 x 658 mm	-	1941/2248 lx ¹	ALE 458	101 442 000 - 000 890 47

* E_m = medium illuminance; E_{max} = maximum illuminance; ¹ Measuring range 100 cm x 100 cm / Measuring distance 100 cm

Integrated machine luminaires



Surface-mounted luminaires



Tube luminaires



Arm-mounted luminaires

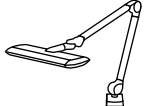

Flexible-tube luminaires

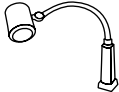

Pivoting-head luminaires



Magnifier luminaires

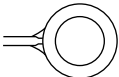

Workplace-system luminaires

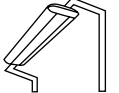









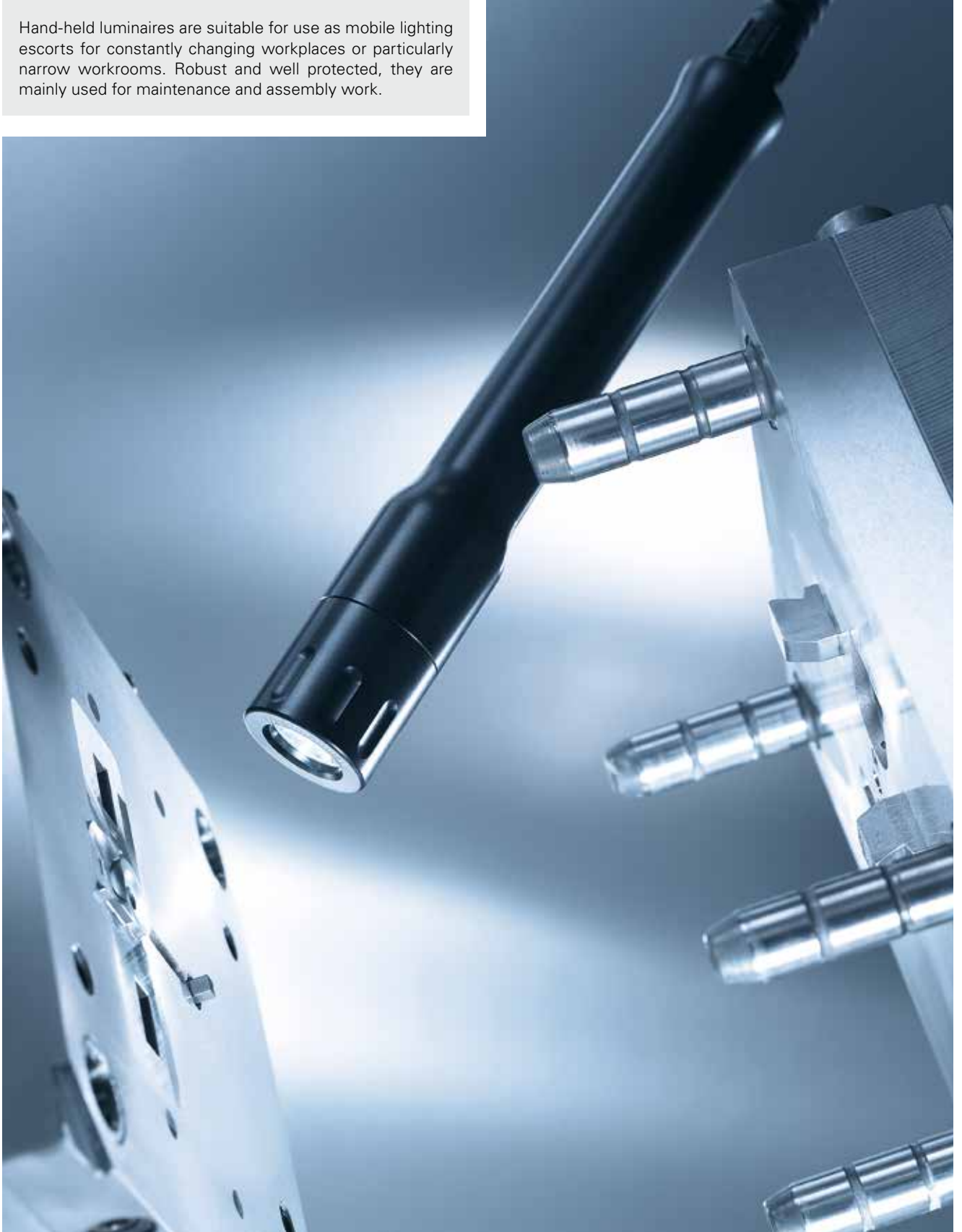









Inspection luminaires



HAND-HELD LUMINAIRES

Hand-held luminaires are suitable for use as mobile lighting escorts for constantly changing workplaces or particularly narrow workrooms. Robust and well protected, they are mainly used for maintenance and assembly work.

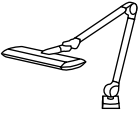
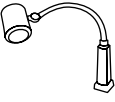
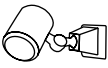
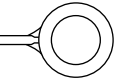
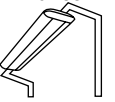
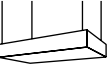

HLWQE		  	150 - 151	<p>Integrated machine luminaires</p> 
HLC		  	152 - 153	<p>Surface-mounted luminaires</p> 
HLWC		  	154 - 155	<p>Tube luminaires</p> 
				<p>Arm-mounted luminaires</p> 
				<p>Flexible-tube luminaires</p> 
				<p>Pivoting-head luminaires</p> 
				<p>Magnifier luminaires</p> 
				<p>Workplace-system luminaires</p> 
				<p>Inspection luminaires</p> 
				<p>Hand-held luminaires</p> 

HLWQE

EXTREMELY HARD-WEARING.

In inaccessible places, good lighting is particularly difficult. It is for this reason that the HLWQE is built to be as small and handy as a mini flashlight. Thanks to state-of-the-art LED technology, this luminaire knows no bounds when it comes to space. It is impact-proof, waterproof and does a good job even when in permanent use in the toughest conditions.

- Variants with narrow and wide angles of illumination
- Also suitable for use under extreme conditions such as high mechanical stress
- Maintenance-free: LED life of up to 50,000 hours and more





efficient^{light}

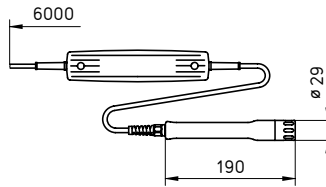

Features at a glance

- 1 x HIGH POWER LED
- Color temperature daylight white 6,000 K
- 6° or 25° angle of illumination
- Black aluminum anodized housing, 2 mm thick safety glass
- Mounting with magnetic luminaire bracket
- Without switch
- System of protection IP20 (IP67 luminaire head); class of protection II
- Supplied with 6 m mains lead and integrated power pack with plug type CEE 7/16 (Euro plug)

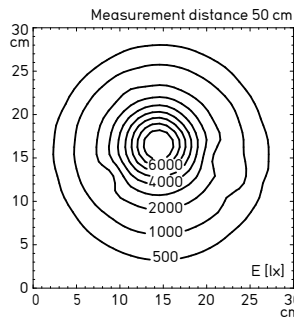

Illuminance with 6° lens

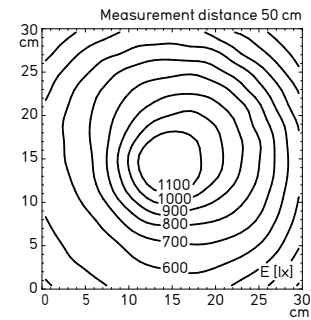

Illuminance with 25° lens

Integrated machine luminaires



Surface-mounted luminaires



Tube luminaires



Arm-mounted luminaires

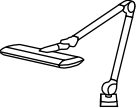

Flexible-tube luminaires

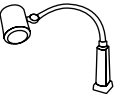

Pivoting-head luminaires



Magnifier luminaires

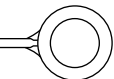

Workplace-system luminaires

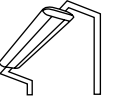

Inspection luminaires



Hand-held luminaires



95 – 240 V, 50/60 HZ

CONSUMPTION	OPERATING DEVICE	DIMENSIONS	SPECIAL FEATURE	E_m/E_{max} *	MODEL	ORDER NO.
3 W	Integrated driver	ø 29 mm	6° lens	1219/8966 lx ¹	HLWQE 1	112 429 000 - 000 742 04
3 W	Integrated driver	ø 29 mm	25° lens	691/1260 lx ¹	HLWQE 1	112 429 001 - 000 743 54

* E_m = medium illuminance; E_{max} = maximum illuminance; ¹ Measuring range 30 cm x 30 cm / Measuring distance 50 cm

HLC

MOBILE POWER FOR YOUR WORKSHOP.



In industrial systems, the actual workroom is often limited, narrow and cramped. And things become even more extreme when you enter areas that rarely see the light of day during the course of maintenance work. To provide optimum visibility in such cases, you'd do well to choose the HLC hand luminaire: It features an extremely compact construction and strong, reliable, glare-free lighting even of unclearly structured rooms.

- Bright hand luminaire for area lighting
- For assembly, control and repair work applications
- Glare protection as a result of in-built reflectors

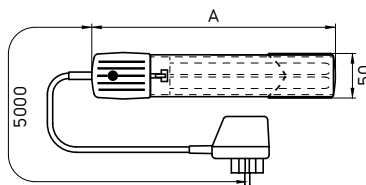

Features at a glance

- TC-S compact fluorescent lamp
- Color temperature neutral white 4,000 K
- Glare-free thanks to in-built reflector
- Black plastic housing
- Suspension by gambrel stick
- Without switch
- System of protection IP20; class of protection II
- Supplied with 5 m mains lead and ballast with plug type CEE 7/17 (shaped plug)

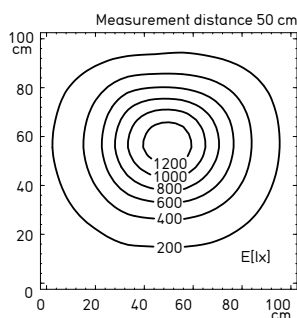

Illuminance based on the example 1 x 11 W

230 V, 50 HZ

FITTED WITH	OPERATING DEVICE	DIMENSIONS	SPECIAL FEATURE	E_m / E_{max} *	MODEL	ORDER NO.
1 x 9 WTC-S	Conventional plug-in ballast	A = 205 mm x 50 mm	–	233/953 lx ¹	HLC 109	101 641 000 - 000 123 63
1 x 11 WTC-S	Conventional plug-in ballast	A = 274 mm x 50 mm	–	330/1310 lx ¹	HLC 111	101 651 000 - 000 123 68

* E_m = medium illuminance; E_{max} = maximum illuminance; ¹ Measuring range 100 cm x 100 cm / Measuring distance 50 cm

Integrated machine luminaires

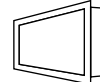

Surface-mounted luminaires

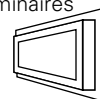

Tube luminaires



Arm-mounted luminaires

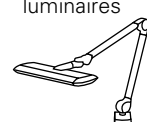

Flexible-tube luminaires



Pivoting-head luminaires



Magnifier luminaires

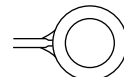

Workplace-system luminaires

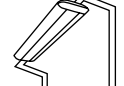

Inspection luminaires



Hand-held luminaires



HLWC

IF THE SITUATION REQUIRES IT.

In working areas with adverse conditions where there is a desire for perfection, indestructible luminaires are required. The HLWC hand luminaire is the perfect choice. And this is because, thanks to its robust construction, it reliably provides bright light even under the influence of moisture and dirt.

- Bright hand luminaire for difficult to access working areas
- Glare protection as a result of in-built reflectors
- For assembly, control and repair work applications
- High system of protection



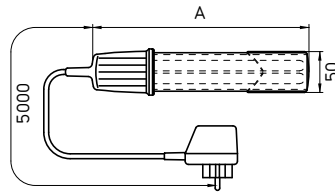

Features at a glance

- TC-S compact fluorescent lamp
- Color temperature neutral white 4,000 K
- Glare-free thanks to in-built reflector
- Black plastic housing
- Suspension by gambrel stick
- Without switch
- System of protection IP67; class of protection II
- Supplied with 5 m mains lead and ballast with plug type CEE 7/17 (shaped plug)

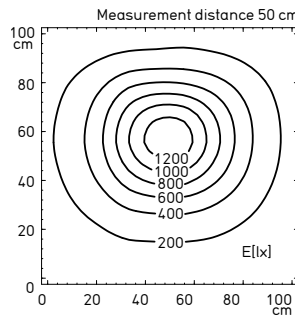

Illuminance based on the example 1 x 11 W

230 V, 50 HZ

FITTED WITH	OPERATING DEVICE	DIMENSIONS	SPECIAL FEATURE	E_m / E_{max}^*	MODEL	ORDER NO.
1 x 9 W TC-S	Conventional plug-in ballast	A = 195 mm x 50 mm	–	233/953 lx ¹	HLWC 109	110 851 000 - 000 647 13
1 x 11 W TC-S	Conventional plug-in ballast	A = 265 mm x 50 mm	–	330/1310 lx ¹	HLWC 111	110 861 000 - 000 141 34

* E_m = medium illuminance; E_{max} = maximum illuminance; ¹ Measuring range 100 cm x 100 cm / Measuring distance 50 cm

Integrated machine luminaires



Surface-mounted luminaires



Tube luminaires



Arm-mounted luminaires

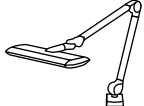

Flexible-tube luminaires

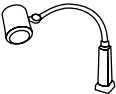

Pivoting-head luminaires



Magnifier luminaires

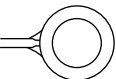

Workplace-system luminaires

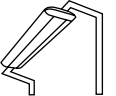

Inspection luminaires



Hand-held luminaires



ACCESSORIES









A Waldmann luminaire is only complete if it satisfies the user from the installation through to the actual application. Of course, this also includes application-friendly accessories.



FASTENINGS			158 - 160	Integrated machine luminaires
CONNECTION TECHNOLOGY			161	Surface-mounted luminaires
TRANSFORMERS FOR HALOGEN LUMINAIRES			161	Tube luminaires
OPERATING DEVICES FOR LED LUMINAIRES			162	Arm-mounted luminaires
MAGNIFIERS			163	Flexible-tube luminaires
PROTECTIVE COVERS			164	Pivoting-head luminaires
				Magnifier luminaires
				Workplace-system luminaires
				Inspection luminaires
				Hand-held luminaires

FASTENINGS

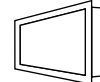
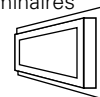
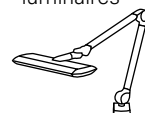
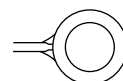

TABLE CLAMP				
		COLOR	SPECIAL FEATURE	ORDER NUMBER
ARM-MOUNTED, FLEXIBLE TUBE AND MAGNIFIER LUMINAIRES		Black	0 – 45 mm	190 008 019 - 000 149 23
		Black	0 – 65 mm	190 007 019 - 000 149 04
		Black	65 – 135 mm	190 033 019 - 000 149 50
		Black	95 – 165 mm	190 035 019 - 000 149 56
		Black	0 – 65 mm, ESD design	190 007 059 - 000 580 94
TABLE FOOT				
		COLOR	SPECIAL FEATURE	ORDER NUMBER
STE 111		Light gray	–	190 037 159 - 000 149 93
		Black	–	190 036 039 - 000 149 59
SN/SNE		Light gray	–	190 036 119 - 000 653 99
		Black	ESD design	190 036 109 - 000 582 38
190 037				
190 036				
MAGNETIC BASE				
		COLOR	SPECIAL FEATURE	ORDER NUMBER
ARM-MOUNTED, FLEXIBLE TUBE AND MAGNIFIER LUMINAIRES		Black	–	190 057 019 - 000 150 56
WALL BRACKET				
		COLOR	SPECIAL FEATURE	ORDER NUMBER
ARM-MOUNTED, FLEXIBLE TUBE AND MAGNIFIER LUMINAIRES		Black	–	300 213 018 - 000 251 78
		White	–	300 213 038 - 000 702 91
		Black	ESD design	300 213 028 - 000 022 77
WALL BRACKET				
		COLOR	SPECIAL FEATURE	ORDER NUMBER
ARM-MOUNTED, FLEXIBLE TUBE AND MAGNIFIER LUMINAIRES		Black	–	D13 148 000
PORTABLE STAND				
		COLOR	SPECIAL FEATURE	ORDER NUMBER
STE 111 SN/SNE		Black	With castors	190 031 019 - 000 731 17
MOUNTING FRAME				
		COLOR	SPECIAL FEATURE	ORDER NUMBER
LUMATRIS		Silver	420 mm	408 001 037 - 005 181 21
		Silver	770 mm	408 001 034 - 005 142 65
MOUNTING BRACKET SET				
		COLOR	SPECIAL FEATURE	ORDER NUMBER
LUMATRIS		Silver	–	408 001 035 - 005 142 68

PIVOTING HEAD			
LUMATRIS	COLOR	SPECIAL FEATURE	ORDER NUMBER
	Silver	Adjustable	408 001 033 - 005 142 62
BRACKET ANGLE			
FLAT LED	COLOR	SPECIAL FEATURE	ORDER NUMBER
	-	Adjustable	203 081 019 - 000 194 78
LUMINAIRE BRACKET			
MACH LED ¹	COLOR	SPECIAL FEATURE	ORDER NUMBER
	-	-	190 174 029 - 000 866 00
LUMINAIRE BRACKET SET			
MACH LED	COLOR	SPECIAL FEATURE	ORDER NUMBER
	-	-	408 001 952 - 004 593 89
LUMINAIRE BRACKET			
RL 40 ¹ MACH LED ¹	COLOR	SPECIAL FEATURE	ORDER NUMBER
	-	-	306 266 022 - 000 859 12
LUMINAIRE BRACKET			
RL 40 ¹	COLOR	SPECIAL FEATURE	ORDER NUMBER
	-	-	190 174 019 - 000 920 88
LUMINAIRE BRACKET			
RL 70 ¹	COLOR	SPECIAL FEATURE	ORDER NUMBER
	-	With rubber profile	SK1 021 719 - 000 854 99
LUMINAIRE BRACKET			
RL 70 ¹	COLOR	SPECIAL FEATURE	ORDER NUMBER
	-	With rubber profile	SK0 995 719 - 000 856 52
LUMINAIRE BRACKET			
RL 70 ¹	COLOR	SPECIAL FEATURE	ORDER NUMBER
	-	With rubber profile	190 015 719 - 000 854 98

¹ Each luminaire requires two brackets.Integrated
machine
luminairesSurface-
mounted
luminairesTube
luminairesArm-mounted
luminairesFlexible-tube
luminairesPivoting-head
luminairesMagnifier
luminairesWorkplace-
system
luminairesInspection
luminairesHand-held
luminaires

Accessories

FASTENINGS

LUMINAIRE BRACKET				
RL 70 ¹		COLOR	SPECIAL FEATURE	ORDER NUMBER
		-	-	190 027 019 - 000 573 37
LUMINAIRE BRACKET				
AWD		COLOR	SPECIAL FEATURE	ORDER NUMBER
		Black	-	191 092 019 - 000 867 27
ADDITIONAL BRACKET		FOR AN ASSEMBLY OF THE SIDE LIGHT ON THE TOP CROSSBEAM THAT CAN BE ROTATED		
TAMETO		COLOR	SPECIAL FEATURE	ORDER NUMBER
		Black	Adjustable	408 001 917 - 005 612 05
LUMINAIRE BRACKET SET		FOR C-RAILS (PAIR)		
TAMETO		COLOR	SPECIAL FEATURE	ORDER NUMBER
		Black	Adjustable	408 001 586 - 005 780 88

¹ Each luminaire requires two brackets.

CONNECTION TECHNOLOGY

SLEEVE				
LUMATRIS		DIMENSIONS	SPECIAL FEATURE	ORDER NUMBER
	M12	Straight; 5-pin	336 615 019 - 005 220 18	
	M12	Angled; 5-pin	336 615 029 - 005 220 15	

Integrated machine luminaires



SLEEVE				
FLATTEC MACH LED		DIMENSIONS	SPECIAL FEATURE	ORDER NUMBER
	M12	Straight; 4-pin	330 634 010 - 000 039 70	

Surface-mounted luminaires



SLEEVE				
HEAD LED		DIMENSIONS	SPECIAL FEATURE	ORDER NUMBER
	M12	Straight; 3-pin	330 603 020 - 000 029 47	

Tube luminaires



CONNECTION CABLE				
MACH LED		DIMENSIONS	SPECIAL FEATURE	ORDER NUMBER
	M12, 3 m	Straight; 5-pin (0.5 mm ²)	336 703 010 - 005 821 09	
	M12, 7 m	Straight; 5-pin (0.5 mm ²)	336 703 020 - 005 433 41	
	M12, 3 m	Angled; 5-pin (0.5 mm ²)	336 704 010 - 005 433 38	
	M12, 7 m	Angled; 5-pin (0.5 mm ²)	336 704 020 - 005 433 44	

Arm-mounted luminaires



CONNECTION CABLE		FOR CONNECTING THROUGH-WIRED LUMINAIRES		
TAMETO		DIMENSIONS	SPECIAL FEATURE	ORDER NUMBER
	3 m	CEE 7/7 / Wieland GST18/3S	226 030 019 - 005 679 77	

Flexible-tube luminaires

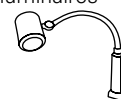



CONNECTION CABLE		FOR CONNECTING THROUGH-WIRED LUMINAIRES (only required for luminaires with dimensions = xx99 mm)		
TAMETO		DIMENSIONS	SPECIAL FEATURE	ORDER NUMBER
	0,3 m	Wieland GST18/3S plug/bushing	330 691 010 - 005 773 61	

Pivoting-head luminaires

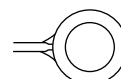

Magnifier luminaires



GROUNDING CABLE				
TANEO WORKING-SYSTEM LUMINAIRE (ESD)		DIMENSIONS	SPECIAL FEATURE	ORDER NUMBER
	1.5 m	Push button 10 mm/eyelet M5	408 001 866 - 005 874 70	
	3.0 m	Push button 10 mm/eyelet M5	408 001 867 - 005 874 73	

Workplace-system luminaires



Inspection luminaires



TRANSFORMERS FOR HALOGEN LUMINAIRES

TRANSFORMER		115/230 V, 50/60 HZ, 23 V				
HSW 20 MHW HGL		CONSUMPTION	CONNECTION	SYSTEM OF PROTECTION	SPECIAL FEATURE	ORDER NUMBER
	60 W	One or more luminaires up to a total of 60 W	IP54	in housing	150 049 019 - 000 506 01	
	60 W	One or more luminaires up to a total of 60 W	–	–	150 048 019 - 000 146 31	

Hand-held luminaires



Accessories

DRIVERS FOR LED LUMINAIRES

DRIVER		220 – 240 V, 50/60 HZ / 350/700 MA				
HEAD LED		CONSUMPTION	CONNECTION	SYSTEM OF PROTECTION	SPECIAL FEATURE	ORDER NO.
		33 W	max. 3 modules in series	–	Clip for hat rail	209 585 039 - 000 040 06
DRIVER		95 – 240 V, 50/60 HZ/350 MA				
ABLL1/ABLTL1		CONSUMPTION	CONNECTION	SYSTEM OF PROTECTION	SPECIAL FEATURE	ORDER NO.
		10 W	max. 7 modules in series	–	Clip for hat rail	209 595 019 - 000 774 27
DRIVER		95 – 240 V, 50/60 HZ/700 MA				
ABLL1/ABLTL1		CONSUMPTION	CONNECTION	SYSTEM OF PROTECTION	SPECIAL FEATURE	ORDER NO.
		10 W	max. 3 modules in series	–	Clip for hat rail	209 585 019 - 000 452 02
DRIVER		24 VAC/DC, 50/60 HZ / 350 MA				
ABLL1/ABLTL1		CONSUMPTION	CONNECTION	SYSTEM OF PROTECTION	SPECIAL FEATURE	ORDER NO.
		5 W	max. 3 modules in series	–	Clip for hat rail	209 582 039 - 004 643 04
DRIVER		24 VAC/DC, 50/60 HZ / 700 MA				
ABLL1/ABLTL1		CONSUMPTION	CONNECTION	SYSTEM OF PROTECTION	SPECIAL FEATURE	ORDER NO.
		14 W	max. 5 modules in series	–	Clip for hat rail	209 582 019 - 000 487 93
DRIVER		120 – 240 V, 50/60 HZ / 24 VDC				
FLAT LED SPOT LED ONE LED MACH LED MACH LED PRO SLIM LED		CONSUMPTION	CONNECTION	SYSTEM OF PROTECTION	SPECIAL FEATURE	ORDER NO.
		20 W	One or more luminaires up to a total of 20 W	IP20	Clip for hat rail	209 585 029 - 000 989 30
DRIVER		220 – 240 V, 50/60 HZ / 24 VDC				
LUMATRIS MACH LED MACH LED PRO SLIM LED		CONSUMPTION	CONNECTION	SYSTEM OF PROTECTION	SPECIAL FEATURE	ORDER NO.
		75 W	One or more luminaires up to a total of 75 W	IP20	–	309 425 020 - 000 108 42
DRIVER		220 – 240 V, 50/60 HZ / 24 VDC				
LUMATRIS MACH LED MACH LED PRO SLIM LED		CONSUMPTION	CONNECTION	SYSTEM OF PROTECTION	SPECIAL FEATURE	ORDER NO.
		75 W	One or more luminaires up to a total of 75 W	IP64	–	309 425 010 - 000 884 34

MAGNIIFIERS

MAGNIIFIER					
		DIMENSIONS	DIOPTERS	SPECIAL FEATURE	ORDER NUMBER
TEVISIO		ø 130 mm	3.5	–	190 208 019 - 005 759 24
MAGNIIFIER					
		DIMENSIONS	DIOPTERS	SPECIAL FEATURE	ORDER NUMBER
TANEO		ø 130 mm	3.5	–	190 207 019 - 005 759 00
MAGNIIFIER					
		DIMENSIONS	DIOPTERS	SPECIAL FEATURE	ORDER NUMBER
STE 111		50 mm x 100 mm	4	–	190 005 019 - 000 148 86
MAGNIIFIER					
		DIMENSIONS	DIOPTERS	SPECIAL FEATURE	ORDER NUMBER
SN SNE		105 mm x 160 mm	3	–	190 182 019 - 000 787 02
MAGNIIFIER					
		DIMENSIONS	DIOPTERS	SPECIAL FEATURE	ORDER NUMBER
HI 20		50 mm x 100 mm	4	–	190 062 019 - 000 150 58
MAGNIIFIER					
		DIMENSIONS	DIOPTERS	SPECIAL FEATURE	ORDER NUMBER
HSW 20		Ø 85 mm	5	–	190 191 019 - 000 434 78
ADD-ON MAGNIIFIER					
		DIMENSIONS	DIOPTERS	SPECIAL FEATURE	ORDER NUMBER
RLL		Ø 112 mm	4	–	190 054 019 - 000 150 51
ADD-ON MAGNIIFIER					
		DIMENSIONS	DIOPTERS	SPECIAL FEATURE	ORDER NUMBER
SNL SNLE		50 mm x 100 mm	4	–	190 080 019 - 000 151 20
		50 mm x 100 mm	4	ESD design	190 080 049 - 000 612 80

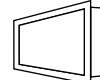
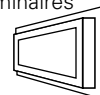
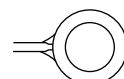
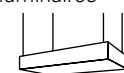
Integrated
machine
luminairesSurface-
mounted
luminairesTube
luminairesArm-mounted
luminairesFlexible-tube
luminairesPivoting-head
luminairesMagnifier
luminairesWorkplace-
system
luminairesInspection
luminairesHand-held
luminaires

Accessories

PROTECTIVE COVERS

ADDITIONAL COVER

TAMETO



DIMENSIONS	SPECIAL FEATURE	ORDER NUMBER
610 mm	Clear	336 748 020 - 005 517 06
910 mm	Clear	336 748 030 - 005 509 16
1210 mm	Clear	336 748 049 - 005 517 12

ANNOTATIONS

Illuminance E_m/E_{max}

The specifications E_m = Medium illuminance and E_{max} = Maximum illuminance are the result of laboratory measurements at 25 °C with a burned-in lamp (Waldmann standard) in a closed, black room. These values can therefore differ at the installation site due to measuring tolerances and other environmental conditions.

Diopter vs. magnification factor

The diopter (dpt) refers to the refractive power of a lens.

The magnification factor is the degree by which the viewed object is magnified.

Magnification factor (x) = $\frac{\text{Diopter of lens}}{4} + 1$

efficient *light*

Waldmann uses this label to identify highly energy-efficient products, which undergo continuous optimization thanks to the development of more efficient and powerful electronic components.



Waldmann always uses the latest electronic components and passes on the benefits of these components to its customers, not least for environmental reasons. This symbol indicates reduced power consumption thanks to new components.

Glare-free

Waldmann offers glare-free technologies for various requirements. Examples include a parabolic louver in combination with a fluorescent lamp or special conical prismatic screen (CDP) for particularly low-glare LED lighting solutions.



EPA

(= Electrostatic Protect Area)

Electrostatically protected area (ESD work station), in which electrostatic charge is prevented by antistatic equipment. Waldmann luminaires bearing this symbol may be used in corresponding areas.

Toughened glass

Waldmann generally uses glass with a thickness of 4 mm as standard to ensure high impact strength and resistance. The glass can withstand even the strongest flying chips without scratching. However, if the glass does break, it shatters into small pieces to ensure a high degree of safety.

Color temperature

The color temperature, measured in Kelvin, represents the color impression of a light source.

- Warm white < 3,300 K
- Neutral white 3,300 – 5,000 K
- Daylight white/cool white > 5,000 K

Color reproduction

The maximum value $R_a = 100$ corresponds to the natural color reproduction of sunlight. Poor color reproduction values for lamps have a negative impact on contrast sensitivity (e.g. for surface inspections, quality inspections, precision work). The colors also look unnatural. Lamps with a minimum color reproduction value of 80 should therefore be used where high/maximum requirements exist for these two features.

Cooling agent/lubricant resistance

Waldmann machine luminaires are tested for resistance to a wide range of cooling agents and lubricants in machine tools. Due to the large number of products on the market and ongoing development in the area of cooling agent/lubricant resistance, Waldmann cannot provide a general guarantee for material resistance. Waldmann can provide individual resistance tests.

LED service life

The service life specification is generally qualified with two values: L70/B50. Waldmann luminaires achieve an LED service life of 50,000 hours if the specified maximum ambient temperature is observed. After this time, the luminous flux of 50 % of the LEDs (B50) is 70 % (L70) of the original value.

Power consumption vs. lamp consumption

The specification in watts for the power consumption of the lamp differs from the consumption of the luminaire. The latter value refers to the entire lighting system, i.e. including the ballast and LED driver.

Fluorescent lamp type T16 = T5

T = tube; number = diameter in eighths of an inch (T5: 5/8") or millimeters (T16: 16 mm ≈ 5/8"). Specifications T5 and T16 are therefore identical.

Light Forming Technology

With this technology, the punctiform lighting characteristic of LEDs is transformed into extremely homogeneous area light. This new development from Waldmann ensures optimum glare-free lighting.



pCon.planner is free software for spatial and interior design planning. Waldmann provides planning files that can be downloaded free of charge from the website for products bearing this symbol.

Ray Mixing Technology

This innovative technology uses the total reflection of special reflector housing. All emitted light beams are therefore optimally mixed whereby punctiform LED light sources are converted into diffuse light.

Classes of protection for electrical equipment

SK I (earthing protection): All electrically conductive housing components are connected to the protective earth conductor system of the fixed electrical installation.

SK II (protective insulation): Reinforced or double insulation between the mains circuit and output voltage or metal housing. There is generally no connection to the protective earth conductor.

SK III (protective extra-low voltage): Equipment in class of protection III operates with protective extra-low voltage (PELV) and requires reinforced or double insulation between mains circuits and the output voltage in mains operation.

Visualizer/segment switching option

The Visualizer function allows the separate switching of light segments in scenarios. This brings forth texture-emphasizing effects that make it easy to detect even the tiniest of faults, such as cracks or differences in the surface texture.

Add-on lens

Bonded add-on lens that provides greater magnification in a small field of vision of the magnifier. The diopters of the magnifier and the add-on lens are added.

HEADQUARTERS GERMANY

Herbert Waldmann GmbH & Co. KG
Postfach 50 62
78057 VILLINGEN-SCHWENNINGEN
GERMANY
Telephone +49 7720 601-100
Fax +49 7720 601-290
www.waldmann.com
sales.germany@waldmann.com

FRANCE

Waldmann Eclairage S.A.S.
Zone Industrielle
Rue de l'Embranchement
67116 REICHESTETT
FRANCE
Telephone +33 3 88 20 95 88
Fax +33 3 88 20 95 68
www.waldmann.com
info-fr@waldmann.com

ITALY

Waldmann Illuminotecnica S.r.l.
Via della Pace, 18 A
20098 SAN GIULIANO MILANESE (MI)
ITALY
Telephone +39 02 98 24 90 24
Fax +39 02 98 24 63 78
www.waldmann.com
info-it@waldmann.com

THE NETHERLANDS

Waldmann B.V.
Lingewei 19
4004 LK TIEL
THE NETHERLANDS
Telephone +31 344 631019
Fax +31 344 627856
www.waldmann.com
info-nl@waldmann.com

AUSTRIA

Waldmann Lichttechnik Ges.m.b.H.
Gewerbepark Wagram 7
4061 PASCHING/LINZ
AUSTRIA
Telephone +43 7229 67400
Fax +43 7229 67444
www.waldmann.com
info-at@waldmann.com

SWEDEN

Waldmann Ljusteknik AB
Skebokvarnsvägen 370
124 50 BANDHAGEN
SWEDEN
Telephone +46 8 990 350
Fax +46 8 991 609
www.waldmann.com
info-se@waldmann.com

SWITZERLAND

Waldmann Lichttechnik GmbH
Benkenstrasse 57
5024 KÜTTIGEN
SWITZERLAND
Telephone +41 62 839 1212
Fax +41 62 839 1299
www.waldmann.com
info-ch@waldmann.com

UNITED KINGDOM

Waldmann Lighting UK Ltd.
Elmfield Road
Morley
LEEDS LS27 OEL
UNITED KINGDOM
Telephone +44 113 2775662
Fax +44 113 2775775
www.waldmann.com
enquiries@waldmannlighting.co.uk

USA

Waldmann Lighting Company
9, W. Century Drive
WHEELING, ILLINOIS 60090
USA
Telephone +1 847 520 1060
Fax +1 847 520 1730
www.waldmannlighting.com
waldmann@waldmannlighting.com

CHINA

Waldmann Lighting Shanghai Pte. Ltd.
Part A, No. Five Normative Workshop
199 Changjian Road, Baoshan
SHANGHAI, P.R.C. 200949
CHINA
Telephone +86 21 5169 1799
Fax +86 21 3385 0032
www.waldmann.com
info@waldmann.com.cn

SINGAPORE

Waldmann Lighting Singapore Pte. Ltd.
22 Cross Street, #02-50/51
South Bridge Court
SINGAPORE 048421
SINGAPORE
Telephone +65 6275 8300
Fax +65 6275 8377
www.waldmann.com
sales-sg@waldmann.com

INDIA

Waldmann Lighting Pvt. Ltd.
Plot No. 52
Udyog Vihar
Phase-VI, Sector-37
GURGAON-122001, Haryana
INDIA
Telephone +91 124 412 1600
Fax +91 124 412 1611
www.waldmann.com
sales-in@waldmann.com